

## 50 W Dimmable two channel Freedom LED driver

Product code: 5778

50.4 W 220 – 240 V 0/ 50 – 60 Hz

- Future-proof Freedom Interface to power Freedom Node, enabling support for various wireless lighting control systems
- 2-channel control for tunable white in human centric lighting, now wireless
- Also DualControl mode available for e.g. direct/indirect light luminaires
- Ultra wide 0.1 % - 100 % dimming range per single channel in both modes
- Wide dynamic range of colour temperatures on all dimming levels
- D4i-aligned Smart Data features
- Amplitude dimming for the highest quality light output, complying with IEEE 1789 recommendation
- Suitable for emergency lighting use
- NFC technology for wireless configuration



### Functional Description

- Suitable for both CCT control (Tunable white mode) and two separate channel control (DualControl mode)
- Adjustable constant current output 100 mA to 1200 mA. In DualControl mode up to 1500 mA total current available (1200 mA max. in single channel). Dimming down to 0.1 % per channel.
- D4i-aligned Smart Data features, e.g. energy reporting, diagnostics and maintenance
- NFC configuration for parameter setting (e.g. output current, colour control parameters, DC light level)
- Optimal fit for EPBD/BREEAM/LEED/WELL due to flicker-free light, energy efficiency & monitoring (Smart data) and controllability
- Full load recognition with automatic recovery, open circuit, short circuit and internal thermal protection
- AC/DC input recognition functionality with DC emergency lighting mode and adjustable emergency light level
- Constant Light Output (CLO), adjustable up to 100 000 h (default disabled)
- Inbuilt power supply for external Freedom Node use
- Helvar Freedom Interface Protocol v1.7 support.

### Mains Characteristics

Nominal rated voltage range	220 V – 240 V, 0 / 50 – 60 Hz
AC voltage range	198 VAC – 264 VAC
	Withstands max. 320 VAC (max. 1 hour)
DC voltage range	176 VDC – 280 VDC
DC starting voltage	> 190 VDC
Mains current at full load	0.23 - 0.26 A
Frequency	0 / 50 Hz – 60 Hz
Stand-by power consumption	< 0.5 W*
THD at full power	< 10 %
Leakage current to earth	< 0.7 mA
Tested surge protection	1 kV L-N, 2 kV L-GND (IEC 61000-4-5)
Tested fast transient protection	2 kV (IEC 61000-4-4)

\*] (Networked) standby power < 0,5 W when Node connected with max. 10 mA current to Node

### Insulation between circuits & driver case

Mains circuit - SELV output circuit	Double/reinforced insulation
Output - Driver case	Basic insulation
Mains input - Driver case	Double/reinforced insulation
Mains input - Ground input	Double/reinforced insulation

### Load Output (SELV <60 V)

Output current ( $I_{out}$ )	100 mA – 1200 mA
Accuracy	$\pm 5 \%^{1)}$
Ripple	< 1 % <sup>2)</sup> at $\leq 120$ Hz
PstLM	< 0.2*
SVM	< 0.01*
$U_{out}$ (max) (abnormal)	60 V

1) At 350 - 1200 mA range. 2) Low frequency, LED load: Cree XP-G LEDs.  
\*] At full power, measured with Cree XP-G LED modules.

	100 mA	350 mA (default)	1200 mA
$I_{LED}^*$	100 mA	350 mA (default)	1200 mA
$P_{Rated}^*$	5 W	17.5 W	50.4 W
$U_{LED}^*$	12 – 50 V	12 – 50 V	20 – 42 V
PF ( $\lambda$ ) at full load	0.63	0.89	0.98
Efficiency ( $\eta$ ) at full load	71 %	85 %	88 %

\* In Tunable white mode: the chosen output current and power are divided into two channels according to the chosen CCT and module specifications.

In DualControl mode: the output current of both channels can be separately adjusted within 100 - 1200 mA. Total current can be up to 1500 mA. Maximum power of the two channels together can never exceed given  $P_{Rated}$

## Operating window

### Tunable white mode

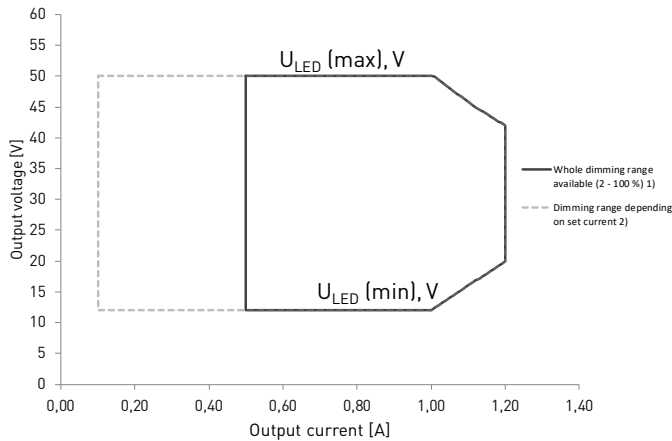

1) From 500 mA to 1200 mA, full dimming range [ 2% - 100% ] and wide CCT dynamic range available in the whole area. Each single channel can dim down to 0.1% level.  
 2) From 100 mA to 500 mA, the absolute minimum dimming level is limited to 10 mA of total current. Dimming / CCT control possible all the way down to that current [dimming range 10% - 100% at 100 mA], but the dynamic range may be limited. Each single channel can dim down to 0.5 mA level.

### DualControl mode

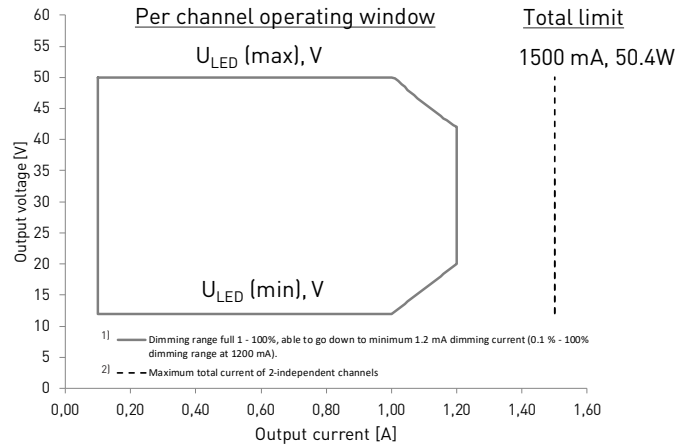

1) At least 1 - 100% dimming range provided on whole operation window. Each channel can go down to 0.1% dimming at 1200 mA (minimum dimming current at whole range is 1.2 mA)  
 2) Each of the channel can operate independently on the operating window shown. The maximum total current of both channels is 1.5 A and the total maximum power is 50.4 W.  
 3) In the DualControl mode, the dimming follows linear dimming curve.

## Driver performance

### Typical efficiency

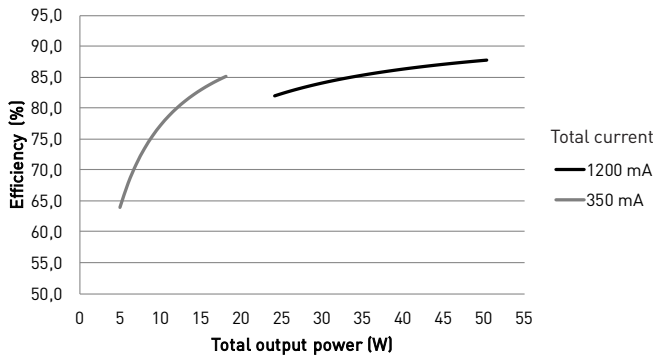

### Typical power factor

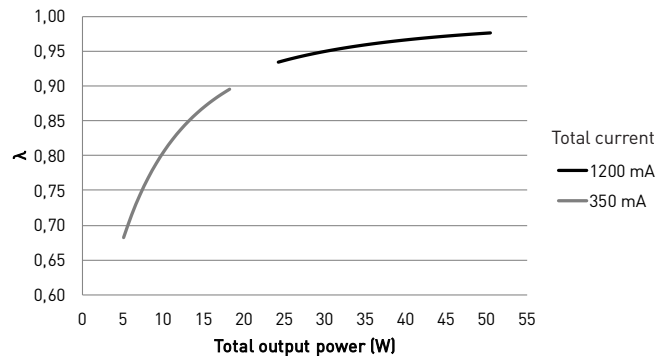

## Operating Conditions and Characteristics

Absolute highest allowed $t_c$ point temperature	75 °C
$T_c$ life (50 000 h) temperature	75 °C
Ambient temperature range	-25 °C ... +45 °C <sup>1) 2)</sup>
Storage temperature range	-40 °C ... +80 °C
Maximum relative humidity	No condensation
Life time(90% survival rate)	100 000 h, at $t_c = 65$ °C 70 000 h, at $t_c = 70$ °C 50 000 h, at $t_c = 75$ °C

1) For other than independent use, higher  $t_a$  of the controlgear possible as long as highest allowed  $t_c$  point temperature is not exceeded  
 2) -25 °C ... +45 °C when current up to 1200 mA. When total current is over 1200 mA (in DualControl mode), the ambient temperature range is -25 °C ... +40 °C

## Selection of the operating mode

This LED driver supports two optional operating modes: Tunable white mode and DualControl mode with two separately controllable channels. The operating mode can be changed either via NFC and Helvar Driver Configurator or then via Freedom protocol. The driver operates in Tunable white mode by default. See detailed operating windows and conditions in both control modes in page 2.

In **Tunable white mode**, the driver reacts to commands of light level and Correlated Colour Temperature (CCT) among others. Common output current is set for both output channels, and then the output current and power are divided into two channels according to the chosen CCT and module specifications. Total maximum power of the two channels can never exceed given  $P_{OUT(MAX)}$ .

In **DualControl mode**, the output current of both channels can be separately adjusted within 100 - 1200 mA and the total current can be up to 1500 mA. However, the integrator has the responsibility to ensure that the loads are chosen in such a way that the maximum power of 50,4 W is never exceeded!

In the DualControl mode, the dimming follows linear dimming curve.

**Important!** If the maximum power is exceeded for some reason, the driver starts to blink the light output. In this situation, shut off the mains supply immediately and check the LED module operating currents and voltages.

### Examples:

- 1st channel 1200 mA 30 V, 2nd channel 300 mA and 20 V. Total current 1500 mA and total power 42W. This is a suitable installation.
- 2) 1st channel 1200 mA 40V, 2nd channel 300 mA and 50 V. Total power is 63 W. This is NOT a suitable installation.

**Tunable white mode**

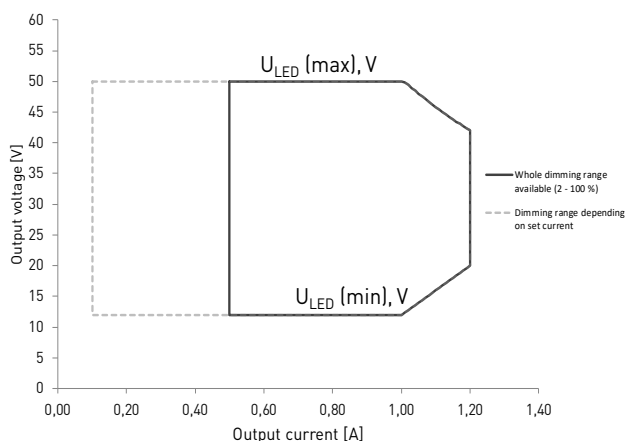

**DualControl mode**

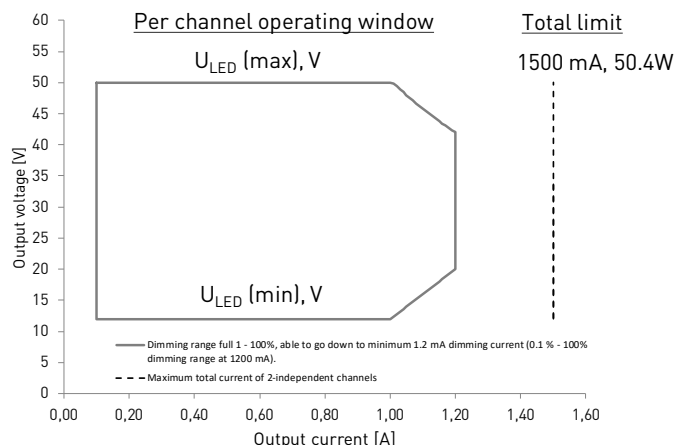

## Quantity of drivers per miniature circuit breaker 16 A Type C

Based on inrush current $I_{peak}$	Typ. peak inrush current $I_{peak}$	1/2 value time, $\Delta t$	Calculated energy, $I_{peak}^2 \Delta t$
65 pcs.	26 A	152 $\mu s$	0.0717 A <sup>2</sup> s

### CONVERSION TABLE FOR OTHER TYPES OF MINIATURE CIRCUIT BREAKER

MCB type	Relative quantity of LED drivers
B 10 A	37 %
B 16 A	60 %
B 20 A	75 %
C 10 A	62 %
C 16 A	100 % (see table above)
C 20 A	125 %

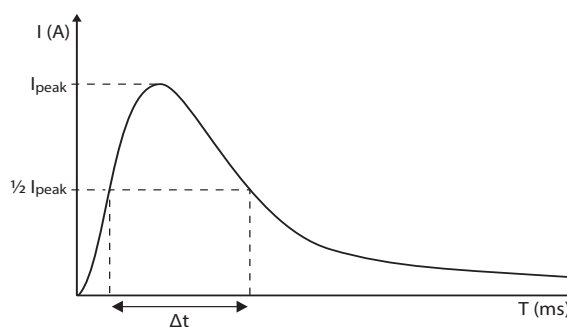

### CONTINUOUS CURRENT

Total continuous current of the drivers and installation environment must always be considered and taken into calculations when installing drivers behind miniature circuit breaker. Example calculation of total drivers amount limited by continuous current:  $n(I_{cont}) = (16 A (I_{nom, Ta}) / \text{“nominal mains current with full load”}) \times 0.76$ . This calculation is an example according to recommended precautions due to multiple adjacent circuit breakers (> 9 MCBs) and installation environment ( $T_a$  30 degrees); variables may vary according to the use case. Both inrush current and continuous current calculations are based on ABB S200 series circuit breakers. More specific information in ABB series S200 circuit breaker documentation.

NOTE! Type C MCB's are strongly recommended to use with LED lighting. Please see more details in "MCB information" document in each driver product page in "downloads & links" section.

**Amplitude dimming technology**

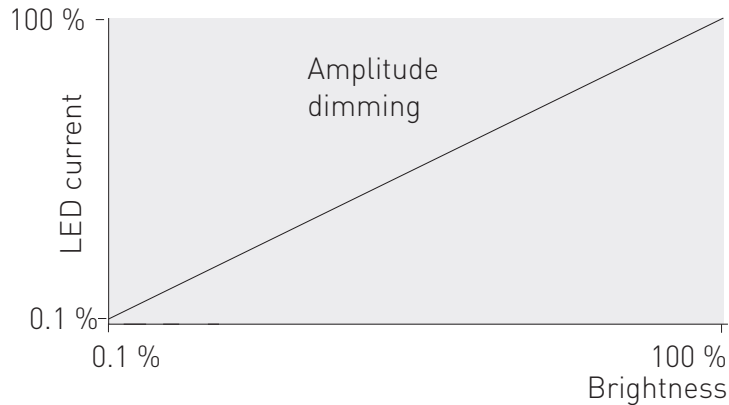

Dimming range per single channel	Dimming range in tunable white use	Dimming technology
0.1 % - 100 %	2 % - 100 %	Amplitude (DC)

LL50iC-FD-100-1200 LED driver implements amplitude dimming technology across whole dimming range. Amplitude dimming offers the best available technology for dimming the light output in an accurate and flicker-free way to ensure high quality lighting in even the most demanding situations such as camera recording applications. Amplitude dimming technology complies with IEEE 1789-2015 recommendations of current modulation to mitigate health risks to viewers.

**Dynamic range and dimming range in Tunable white control**

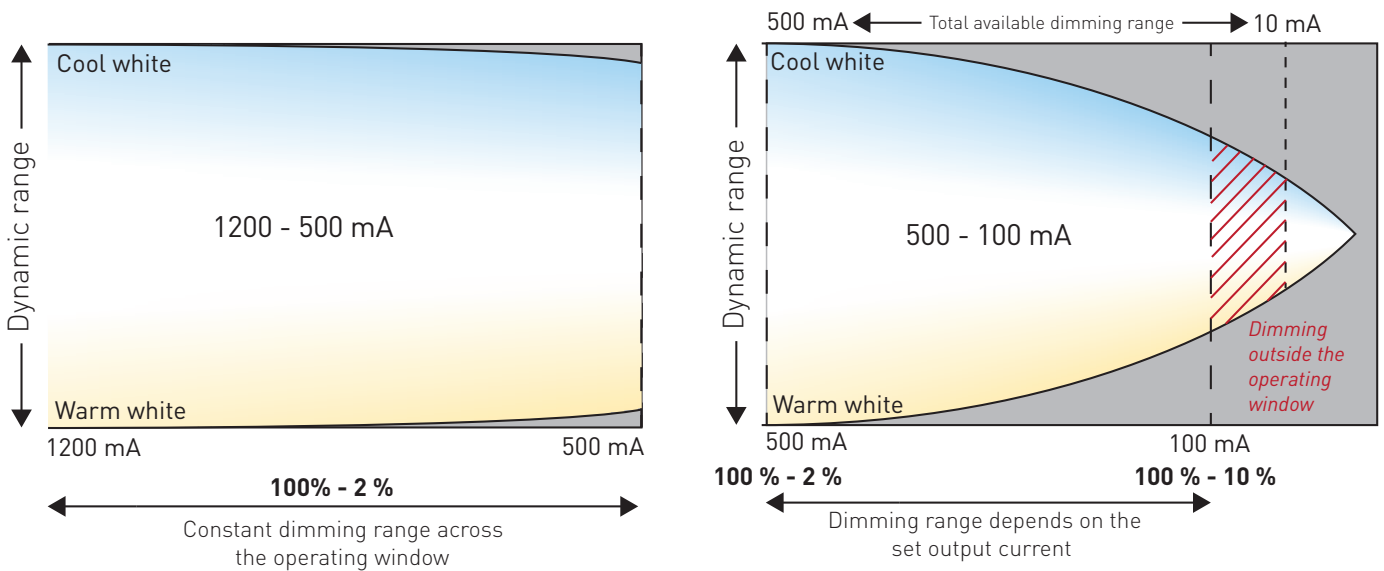

LL50iC-FD-100-1200 LED driver is ready to be used out of the box.

Highest precision and color consistency in controlling combinations of different luminaire types is achieved by setting colour temperatures and lumen outputs before use with Helvar Driver Configurator. The configured colour temperatures of the channels should match the ones of the LED modules used. The factory default settings of cool and warm channels are 6500 K and 2700 K accordingly.

After setting up the colour temperatures, the lumen output values of full dimming level (100 %) should be configured for both channels. By default, output currents are set to be equal in both channels.

## Freedom power output as external “luminaire intelligence unit” supply

Helvar Freedom drivers support external control unit usage with the Freedom Node power output. The driver can use the Freedom Node output terminal to supply power and connect with Freedom Node - intelligent communication units via UART digital communication. The power supply specification and pin order for connector are listed in the details below. For further SW side integration, please contact Helvar.

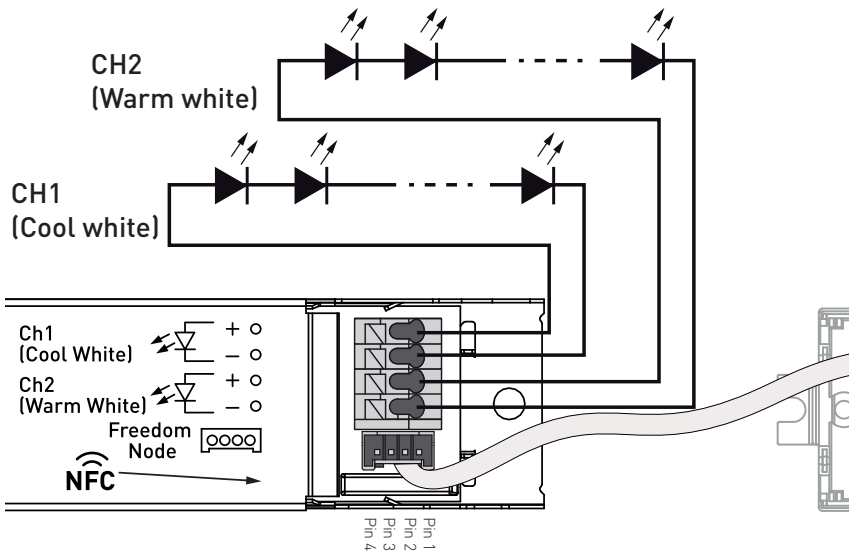

### Pin connections

Pin 1	Rx (Digital signal)*
Pin 2	Ground
Pin 3	VDD
Pin 4	Tx (Digital signal)*

\* Rx/Tx From LED driver perspective.

### Power supply specification

Voltage	3.3 V ( ±0.3 V)*
Continuous current	max. 16 mA
Peak current	30 mA (max. 100 ms each 5 Hz cycle)
Standby mode current	max. 10 mA**
Connector	MOLEX (35363-0460)

\* Not continuous voltage supply by default.

\*\* [Networked] standby power < 0,5 W when current max. 10 mA. Up to 16 mA technically possible.

The UART communication follows Helvar Freedom Interface Protocol v1.7 by default. For more details about the communication protocol, please contact Helvar.

## Wireless configuration

LL50iC-FD-100-1200 LED driver is equipped with NFC wireless technology for effortless configuration of the driver via Helvar Driver Configurator Support. HDC enables easy-to-use automatic configuration of the driver parameters via NFC, without mains connection to the driver. The most popular MD-SIG qualified NFC readers (FEIG CPR30-USB & ISC.MR102-USB) are supported giving flexibility for the operator. For further information about the usage with Helvar Driver Configurator, please see the user guide at [www.helvar.com](http://www.helvar.com)

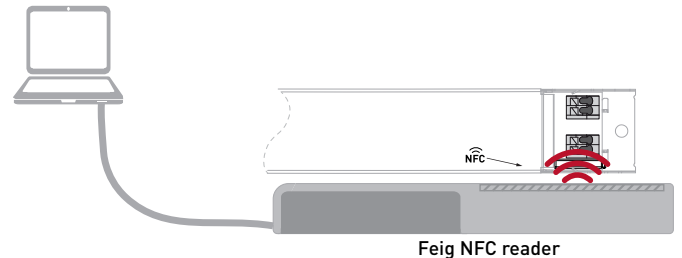

## D4i-aligned Smart Data Features

This driver has integrated Smart Data features, which monitor, gather and provide key data about the LED driver usage and internal parameters in convenient format through the Freedom protocol. Smart Data contents are aligned to match with the the latest D4i specifications (based on DALI parts 251-253) of smart LED driver data features. This useful data provided by LED driver enables various applications and integrations into data management and IoT services provided by control system partners, establishing the Helvar LED drivers as key components in the latest generation of smart luminaires.

The Smart Data features include data sets as described below, accessible via Freedom protocol:

- OEM Customer data
  - Manufacturer GTIN
  - Manufacturer ID number
- Energy reporting
  - Active energy consumption
  - Active power
  - Apparent power
  - Load side power
- Diagnostics and maintenance
  - Cumulative control gear operating time
  - Control gear start counter
  - Control gear failure status
  - Supply voltage & frequency
  - Output voltage & current
  - Output power limitation (shutdown)
  - Open circuit detection
  - Short circuit detection
  - Control gear internal temperature
  - Control gear thermal derating point
  - Control gear thermal shutdown point
  - Light source on time (resettable)
  - Light source start counter (resettable)
  - Light source failure status

## Internal thermal protection

This LED driver has built-in internal thermal protection. This feature protects the LED driver by starting to decrease the maximum output current when the temperature rises enough above the specified operating environment of the driver. If the temperature exceeds a certain predefined critical point, the output will be switched off and returns automatically once the temperature decreases below the threshold. The exact triggering points vary depending of the LED driver model. By default, the feature will never be triggered below the point of  $T_c$  max temperature being exceeded and will thus not affect normal operation of the LED driver.

Internal thermal protection feature is enabled by default, and it can be either disabled or manually adjusted to trigger earlier if desired. Configuring the internal thermal protection is done via Helvar Driver Configurator or Freedom protocol.

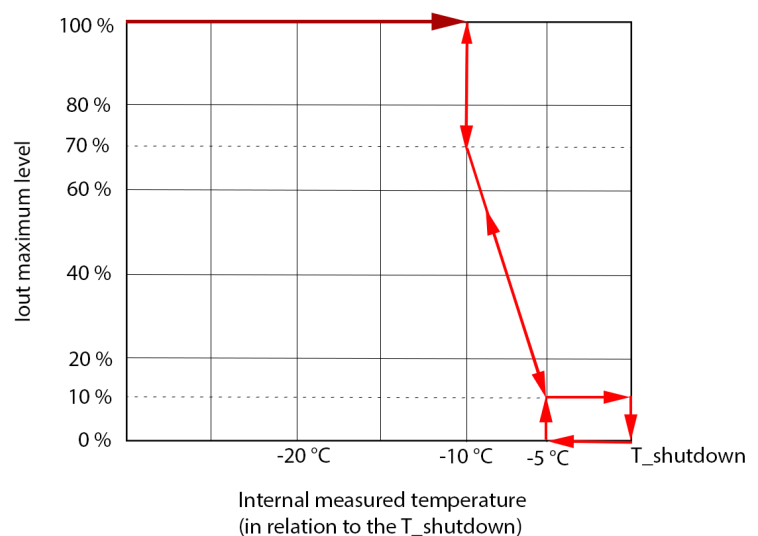

## Connections and Mechanical Data

Wire size	0.5 mm <sup>2</sup> – 1.5 mm <sup>2</sup>
Wire type	Solid core and fine-stranded
Wire insulation	According to EN 60598
Maximum driver to LED wire length	1.5 m
Weight	266 g
IP rating	IP20

## Connections

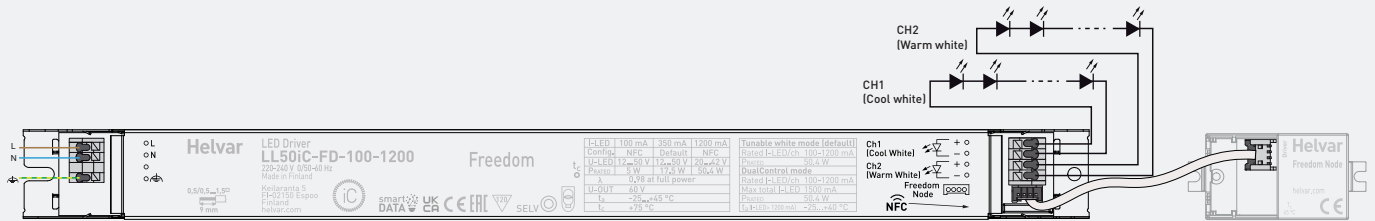

**Note:**

- Earth connection to PE terminal is optional and not needed for the functionality of the driver. See page 8 for details.
- Not suitable for load side switching operation

## Dimensions (mm)

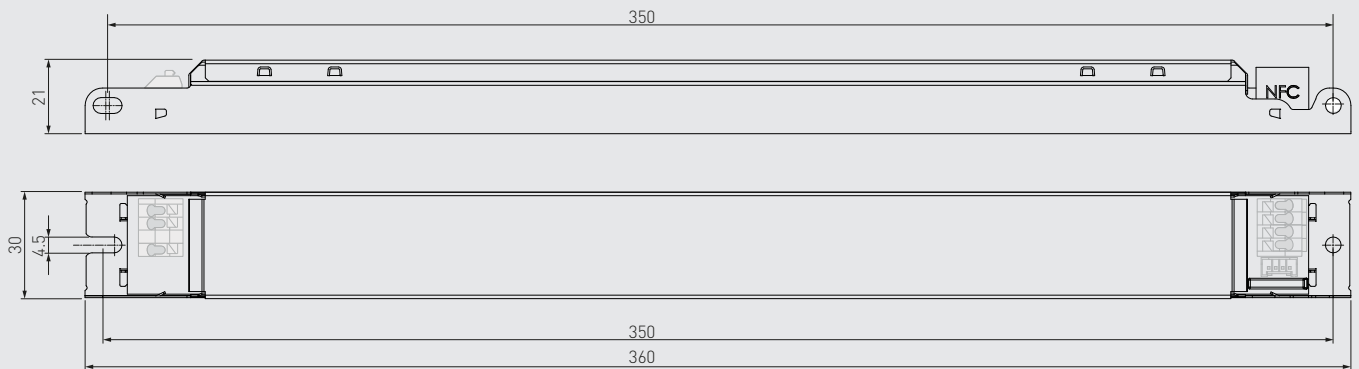

LL50iC-FD-100-1200 LED driver is suited for built-in usage in luminaires. In order to have safe and reliable LED driver operation, the LED luminaires will need to comply with the relevant standards and regulations (e.g. IEC/EN 60598-1). The LED luminaire shall be designed to adequately protect the LED driver from dust, moisture and pollution. The luminaire manufacturer is responsible for the correct choice and installation of the LED drivers according to the application and product datasheets. Operating conditions of the LED drivers may never exceed the specifications as per the product datasheet.

## Installation & operation

### Maximum ambient and $t_c$ temperature:

- For built-in components inside luminaires, the  $t_a$  ambient temperature range is a guideline given for the optimum operating environment. However, integrator must always ensure proper thermal management (i.e. mounting base of the driver, air flow etc.) so that the  $t_c$  point temperature does not exceed the  $t_c$  maximum limit in any circumstance.
- Reliable operation and lifetime is only guaranteed if the maximum  $t_c$  point temperature is not exceeded under the conditions of use.

### Current setting

LL50iC-FD-100-1200 LED driver features a constant current output programmable via NFC or via Freedom protocol. When using the NFC current set, the following things shall be considered:

- After the driver has been disconnected from mains, it is recommended to wait 30 s before starting to program via NFC.
- The driver shall not be connected to the mains if active NFC field is nearby.

### LED driver earthing

- LL50iC-FD-100-1200 is LED driver suitable for Class I and II luminaires. When used inside **Class I or Class II** luminaires, the earth cable is recommended to be connected to improve the EMC performance of the driver, but it is not mandatory. It is the responsibility of the integrator to ensure that the assembled luminaire EMC performance complies with the latest standards.

### Miniature Circuit Breakers (MCB)

- Type-C MCB's with trip characteristics in according to EN 60898 are recommended.
- Please see more details in "MCB information" document in each driver product page in "downloads & links" section.

## Helvar Driver Configurator support

LL50iC-FD-100-1200 LED driver is supported by Helvar Driver Configurator software. The output current of the LL50iC-FD-100-1200 driver can be programmed using Helvar Driver Configurator, as well as OEM customer data fields, operating mode (Tunable white or DualControl) and parameters for functions such as CLO and Tunable White behavior. Also the AC/DC input recognition and emergency lighting mode parameters (DC emergency light level, DC dimming) can be adjusted through HDC. Programming the driver with Helvar Driver Configurator can be done via NFC.

## Functionality in abnormal conditions

### No load

When open load is detected, driver will go to standby power consumption and remains in automatic recovery mode. In automatic recovery mode, the driver waits till load is returned and once that happens, it returns to normal operation.

### Short circuit

When short circuit is detected, driver goes to automatic recovery mode and follows the same logic as described in the no load condition.

### Overload

When overload is detected, driver goes to standby mode and returns through mains reset.

### Underload

When undervoltage is detected, driver goes to standby mode and returns through mains reset.

### Internal overtemperature

When the driver exceeds the  $T_c$  max operating temperature, soon above that point the driver will start decreasing the maximum output current. It will be gradually decreased down to 10 % level, after which in case the temperature still rises, the output of the driver will be shut down. The output will be returned after the temperature drops below a certain threshold. Parameters of this feature can be adjusted via Helvar Driver Configurator or Freedom protocol.

### AC to DC emergency lighting mode

When AC supply is switched to DC, driver will recognise this and switch to emergency lighting mode. The light level will be adjusted to 15 % of the nominal AC operation output current by default. The DC light level cannot be adjusted or turned off, unless "DC dimming" is specifically enabled through Helvar Driver Configurator. When the AC is switched back on, the driver returns to normal operation. The internal temperature protection feature can never force the light level off or below the set emergency level in DC mode.



## Conformity & standards

General and safety requirements	EN 61347-1
Particular safety requirements for DC or AC supplied electronic control gear for LED modules	EN 61347-2-13
Thermal protection class	EN 61347, C5e
Mains current harmonics	EN 61000-3-2
Limits for voltage fluctuations and flicker	EN 61000-3-3
Radio frequency interference	EN 55015
Immunity standard	EN 61547
Performance requirements	EN 62384
Recommended Practices for Modulating Current in High-Brightness LEDs for Mitigating Health Risks to Viewers	IEEE 1789-2015
Compliant with relevant EU directives	
RoHS/REACH compliant	
CE / UKCA marked	

## Label symbols



Safety isolating control gear with short circuit protection (SELV control gear).



Double insulated control gear suitable for built-in use.



Thermally controlled control gear, incorporating means of protection against overheating to prevent the case temperature under any conditions of use from exceeding 120 °C.



Control gear equipped with NFC wireless technology for effortless configuration.

**Freedom** Control gear supporting wireless luminaire control solutions via Freedom Interface.



Driver is capable of monitoring and measuring key data about driver usage and providing access to that data via Freedom protocol. This includes data sets such as OEM customer data, energy reporting and diagnostics.