

5641 ActiveAhead Node Multisensor High Bay

ActiveAhead Node Multisensor High Bay is a member of the truly intelligent wireless lighting control solution Helvar ActiveAhead®. It can be used as a wireless sensor to control nearby other ActiveAhead nodes in the Bluetooth® mesh network. It also connects standard DALI devices to the ActiveAhead system offering flexible options for the installation. Node Multisensor High Bay offers addressed local DALI control line which allows individually set light output levels for the connected DALI luminaires to suit the space and scene needs. In addition to the DALI luminaires, also relays, dimmers and additional Helvar DALI system sensors can be connected to the DALI control line.

The ActiveAhead Node Multisensor High Bay is mains powered and includes an inbuilt DALI power supply unit to power the local DALI control line. This makes the design and installation easy as wiring is simple. The unit can be surface mounted to a solid surface using the included surface mount box. Flush mounting accessories are available (sold separately) when unit is to be flush mounted to a ceiling using spring clips.

The connected ActiveAhead nodes share information, such as movement detections, through the mesh network, and a mobile app allows you to configure the system where needed. Thanks to its smart software algorithm, Helvar ActiveAhead is able to learn how the space is used to predict the connected luminaires operation accordingly. Learning is based on the data that the node receives from locally connected sensors and from other ActiveAhead nodes in the network. Since it never stops learning, the ActiveAhead Node Multisensor High Bay will adapt to any future changes in its environment, such as a wall installation or removal.



Key Features

- Use as a wireless sensor on the Helvar ActiveAhead mesh network and / or connect DALI devices into the network.
- Offers local addressed DALI control line
- Customisation via mobile app
- Quick and simple installation with mains power and inbuilt DALI power supply unit.

Detection

Detection Coverage

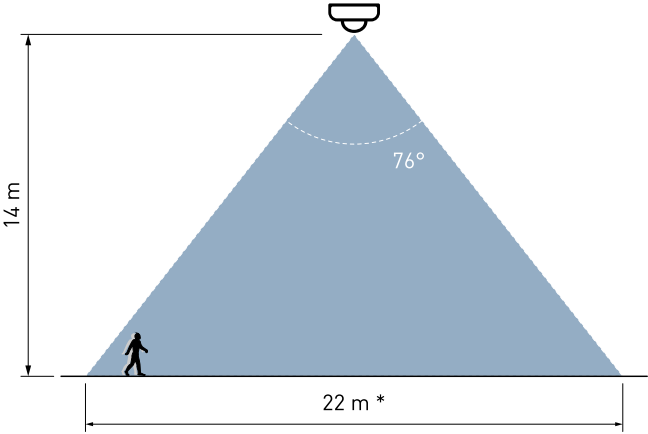

* = big movement

Detection Pattern

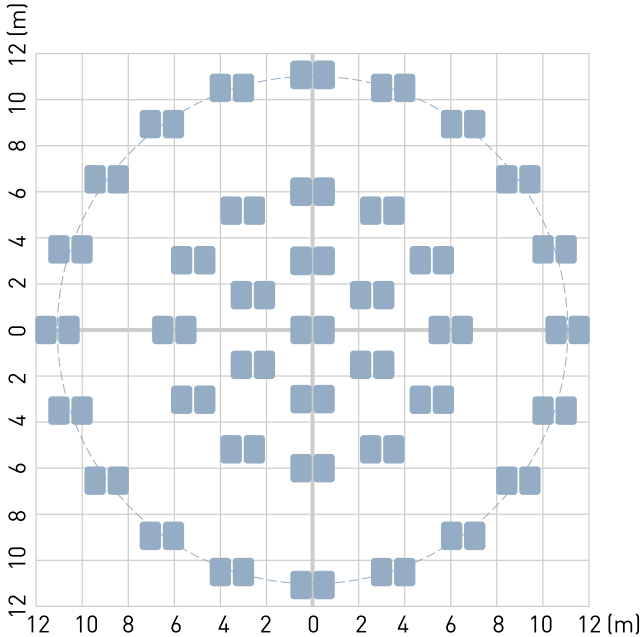

Installation Diagram

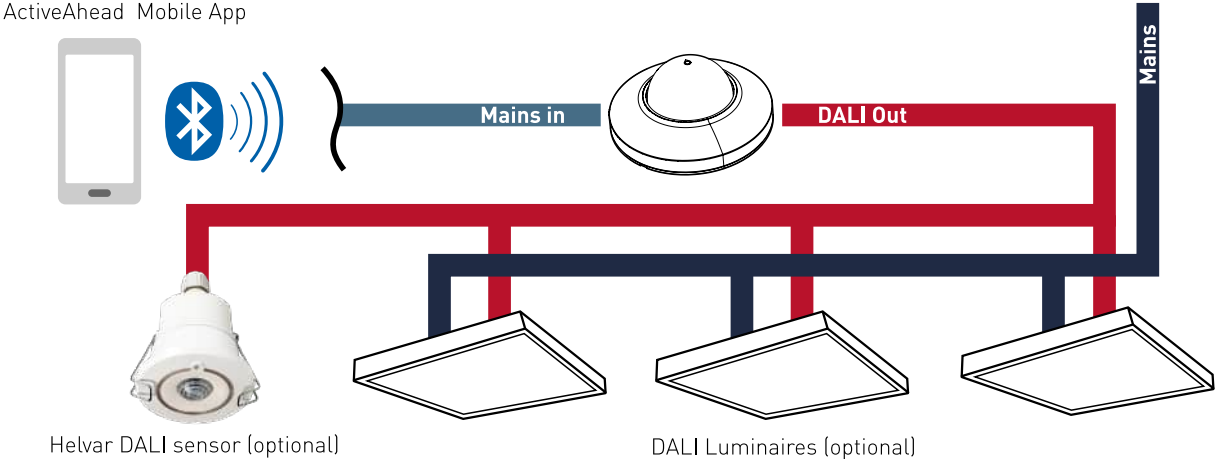

Connections

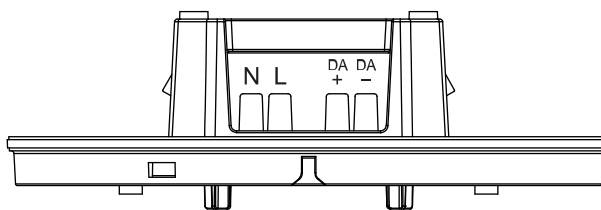
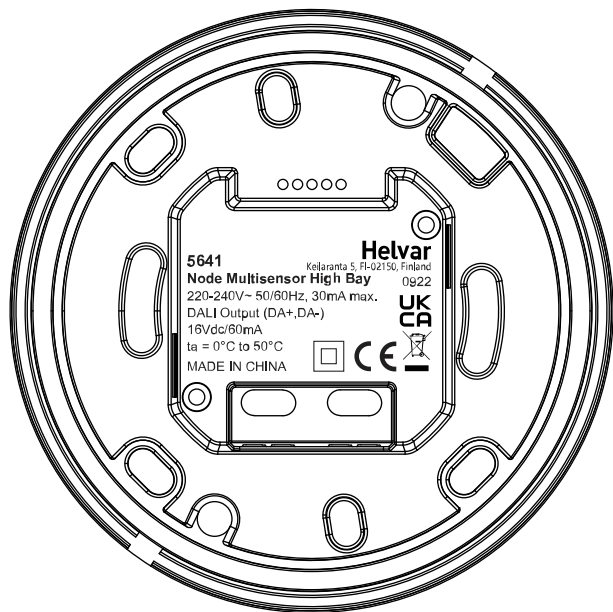

Dimensions (mm)

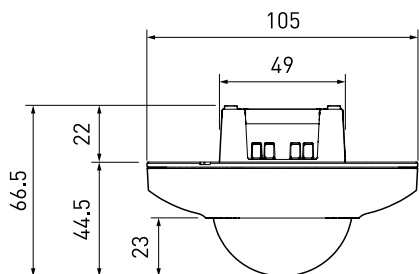

Standard

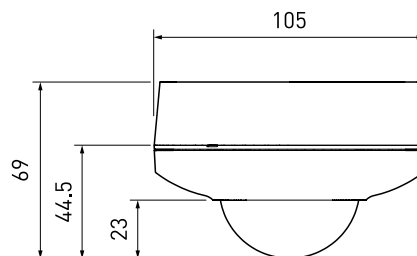

w/ Surface-Mounted Box (included)

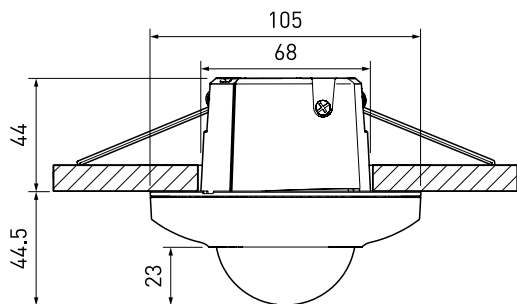

w/ Recess Spring Mount (accessory)

Technical Data

Supported DALI device types

- DT0: Fluorescent lamp control gear
- DT1: Self-contained emergency control gear
- DT4: Incandescent lamp dimmer
- DT5: Analog-to-digital converter, Conversion to DC (0/1-10 V)
- DT6: LED lamp control gear
- DT7: Switching (relay) control gear
- DT8: Colour control gear (colour temperature Tc only)
- Part 303 Occupancy sensors
- Part 304 Light sensors
- Helvar DALI system sensors: 320, 321, 322, 341 and 342

Connections

- Mains:** Wire section: 0.5–2.5 mm² solid or stranded
- DALI cable:** Wire section: 0.5–2.5 mm² solid or stranded
- Cable stripping length:** 6–8 mm

Electrical data

- Input voltage:** 220–240 VAC, 50/60 Hz
- Input current:** Max. 30 mA
- Input power:** Max. 3.5 W
- Output current for DALI:** Typical 60 mA (Max. 250 mA)

Sensors

- Light sensor:** For bright-out function
- Presence detector:** Passive infrared (PIR)
- Max. recommended mounting height:** 14 m

Wireless Connectivity

- Frequency:** 2.4 GHz
- Technology:** Bluetooth Mesh
- Antenna Pattern:** Omnidirectional
- Max distance between Nodes:** 15 m in free space

Note: To ensure proper operation the mesh network must consist of a minimum 10 ActiveAhead Nodes.

Operating and storage conditions

- Number of connected DALI devices:** Max 16 addresses or 60 mA

Note: The total number of connected devices is limited by the addresses, the DALI current consumption limitation.

- Operating temperature:** 0 °C to +50 °C

Note: The temperature difference between the detection target and the background must be at least 4 °C.

- Relative humidity:** Max. 90 %, noncondensing
- Storage temperature:** –40 °C to +70 °C
- Max. DALI cable length:** 300 m

Mechanical data

- Dimensions:** 105 × 66.5 mm
105 x 69 mm with surface box
105 x 88.5 mm with flush mount
- Material (casing):** Polycarbonate
- Weight:** 130 g / 177 g (with packaging)
- Safety class:** Class II
IP20 with EU standard junction box or spring clip box
IP54 with surface mounting box

Order Codes

5641: Colour: White (RAL 9003)

5641B: Colour: Black (RAL 9005)

Delivered with Surface-Mounted Box and PIR detection mask.

Accessories (sold separately):

5001 Recess Spring Mount

Conformity and standards

Conformity: 

EMC emission / immunity: EN 55015 / EN 61547

Safety: EN 61347-1, EN 61347-2-11

RED: EN 300 328, EN 301 489-1, EN 301 489-17

Isolation mains to DALI: Basic isolation

Environment: Complies with REACH and RoHS directives.