

Surface-Mount PIR Switching Sensor (SS-PIR-SW-01)

The SS-PIR-SW-01 is a PIR-triggered switch suitable for mounting onto a back box or directly onto a solid surface. It allows simple selection of presence or absence detection to control both lighting and nonlighting loads.

Configurable for any room occupancy style, it switches on the connected load if the area is occupied and the illuminance is lower than the specified level (with the photocell activated). Similarly, it switches off the load if the area is unoccupied for the set time.

In absence mode, the unit can also be operated from a mains-rated retractive wall switch.

Features

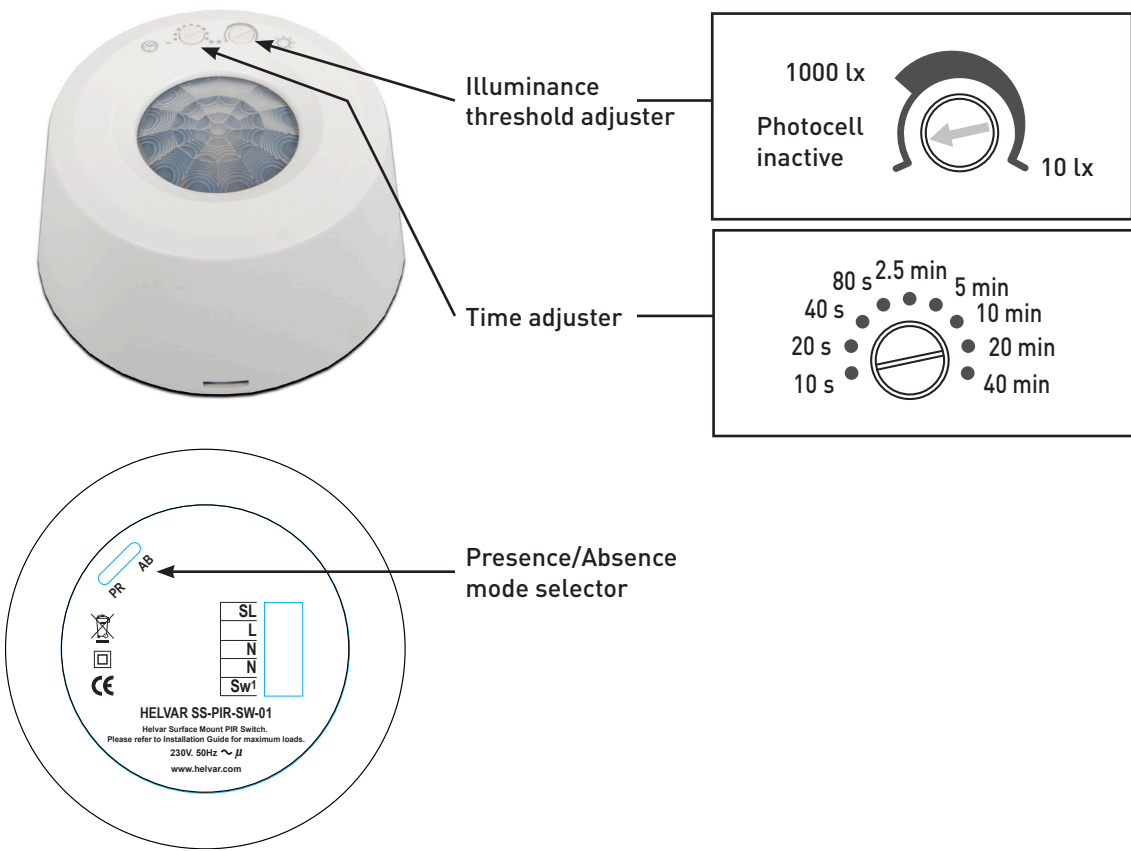

Operation

Presence Mode (Default Mode)

Out of the box, the time-out adjuster is set to 10 s, and the illuminance threshold adjuster is set to maximum (photocell inactive). With the illuminance threshold adjuster set to maximum, the sensor will always switch on the connected load when movement is detected. There are nine time periods available from the time-out adjuster (from 10 s to 40 min).

Multiple sensors can be connected to the same load in order to extend the detection zone [see 'Multiple sensors' on page 2].

Absence Mode

With the mode selector set to absence detection mode, pressing a retractive switch connected to the sensor will switch on the connected load. Then, if no presence is detected for the selected time period, or if the retractive switch is pressed shortly, the load will be switched off.

Connections

Single sensor

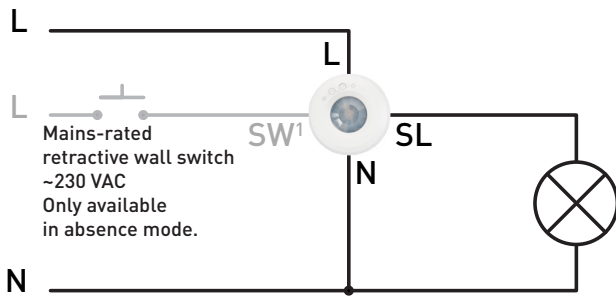

L: Live in SW¹: Switch input (only in absence mode)
 N: Neutral in SL: Switched live

Multiple sensors

(Presence detection mode only)

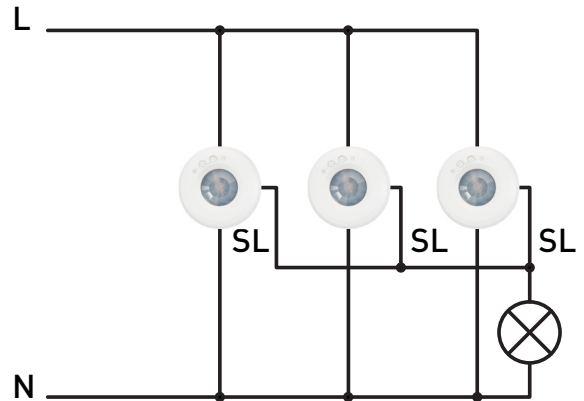

Detection Pattern

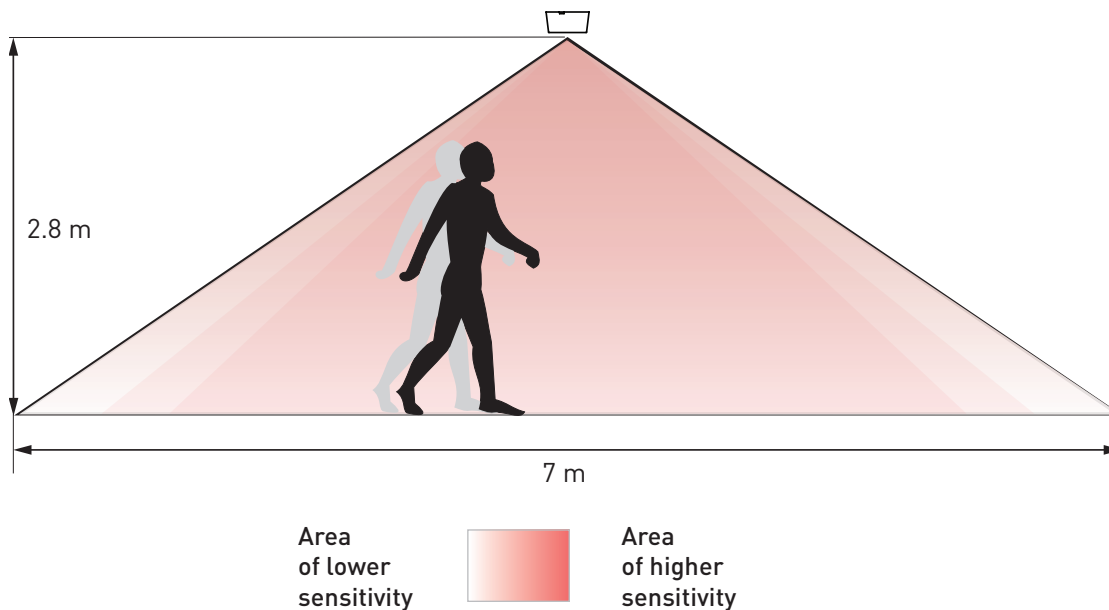

Installation Notes

- Position the sensor so that the occupants of the room are normally inside the detection zone.
- Do not fix the sensor to an unstable or vibrating surface.
- Do not install the sensor within 1 m of any lighting, forced air heating, or ventilation equipment.
- Do not install several sensors in parallel near lamps that emit infrared radiation if these lamps are switched via another PIR switch. This can cause false triggering.
- Make sure that the wires and cables are securely held within the connection terminals.
- Do not connect on a circuit with large inductive loads, as induced spikes can cause false triggering or damage the sensor.
- Protect the sensor by a 6 A MCB or fuse.
- Disconnect the sensor from the circuit before performing insulation testing of the wiring circuit.

Connection and Fixing

- 1.** On the back mounting plate, knock out the mounting holes or predrill the pilot holes for the screws.

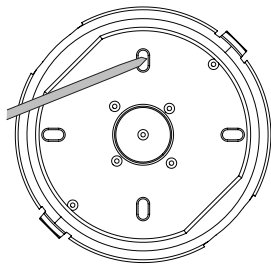

- 2a.** Rear entry —or—
On the back mounting plate, knock out the rear entry hole for the cable.

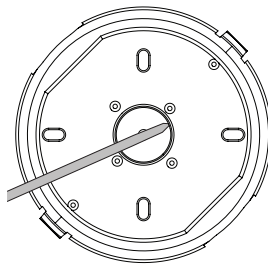

- 2b.** Side entry
On the sensor head and back mounting plate, knock out the required side entry for the conduit and/or the cables.

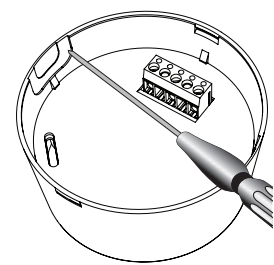

- 3a.** Rear entry —or—
Pass the cable through the rear entry hole on the back mounting plate.

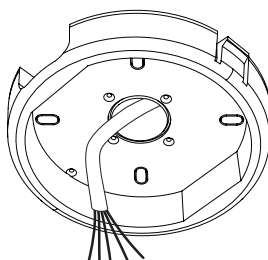

- 3b.** Side entry
Pass the cable through the side entry point on the back mounting plate.

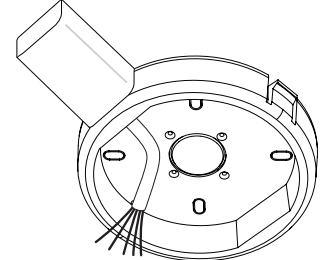

- 4** Screw the back mounting plate to the ceiling or back box via the mounting holes.

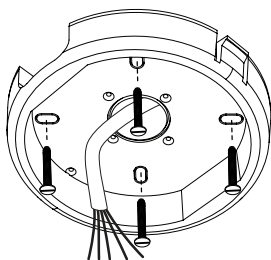

- 5** Wire the cables into the block terminal.

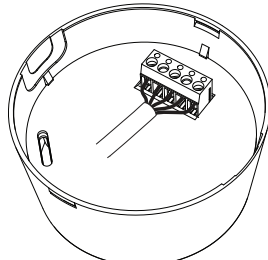

- 6** Push the sensor head onto the back mounting plate. Then align the clips with the slots on the sensor heads.

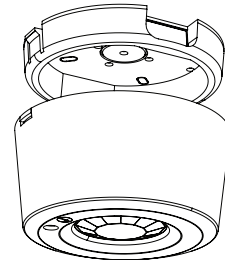

Setup

Presence Mode

Auto on, auto off via time-out settings (no manual wall switch control). Multiple sensors can be connected to the same load in order to extend the detection zone (see figure in section 'Multiple sensors' on page 2). When used in conjunction with illuminance settings, the load will only switch on if the detected light levels are below the minimum level set on the illuminance threshold adjuster.

Absence Mode

Manual on via wall switch, auto off via time-out settings or manual off via wall switch. Single sensors only. Not for use with multiple sensors in parallel.

Illuminance Setup

Notes: It is best to adjust the illuminance setting when the ambient light level is at the required minimum level.

For loads that should switch on regardless of ambient light levels, set the illuminance setting to maximum (photocell inactive).

1. Set the illuminance setting to minimum and wait for the load to switch off.
2. Slowly increase the illuminance setting while waving your hand below the sensor until the connected load switches on.

Time Setup

Set the time appropriately for the usage of the area. For example, some possible settings could be:

- Offices with workers regularly walking: 20 min
- Offices with mainly desk-based workers: 40 min
- Corridors: 5 min
- Washrooms with total coverage: 10 min
- Washrooms with entry coverage only: 40 min
- 2D fittings: Not less than 20 min, due to potential lamp failure. If in doubt, contact your lamp manufacturer.

Technical Data

Electrical data

External power: Terminal block
Wire section: 0.5 mm² – 2.5 mm²
solid or stranded

Cable rating: All cables must be mains rated.

Mains supply: 230 VAC, 50 Hz

Loads
6 A resistive (e.g. heater)
4 A incandescent
3 A fluorescent ballast / LED driver
1 A inductive (e.g. fan/motor)
Mains LED lamps: Equivalent to 1000 W halogen light output
Min. load: 2 W resistive, suitable for most energy saving lamps, LEDs and emergency fittings.

External protection: 6 A maximum (MCB or fuse)

Illuminance: 10 lx to 1000 lx, or photocell inactive.

Sensors

Presence detector: PIR (Passive InfraRed)

Detection range 360° with up to 7 m diameter when mounted at a 2.8 m ceiling height

Time: 10 s to 40 min

Mechanical data

Mounting hole diameter: 50 mm

Diameter: 86 mm

Material (casing): Flame-retardant polycarbonate

Finish / Colour: Matt / White RAL9003

Weight: 102 g

IP code: IP20

Operating conditions

Ambient temperature: +10 °C to +35 °C
Note: The temperature difference between the detection target and the background must be at least 4 °C.

Relative humidity: Max. 90 %, noncondensing

Storage temperature: -10 °C to +70 °C

Conformity and standards

EMC emission: EN60669-2-1:2004 inc A12:2010

EMC immunity: EN60669-2-1:2004 inc A12:2010

Safety: EN60669-2-1:2004 inc A12:2010

Environment: Complies with WEEE and RoHS directives.

Version information

Hardware version: Rev. 1

Dimensions (mm)

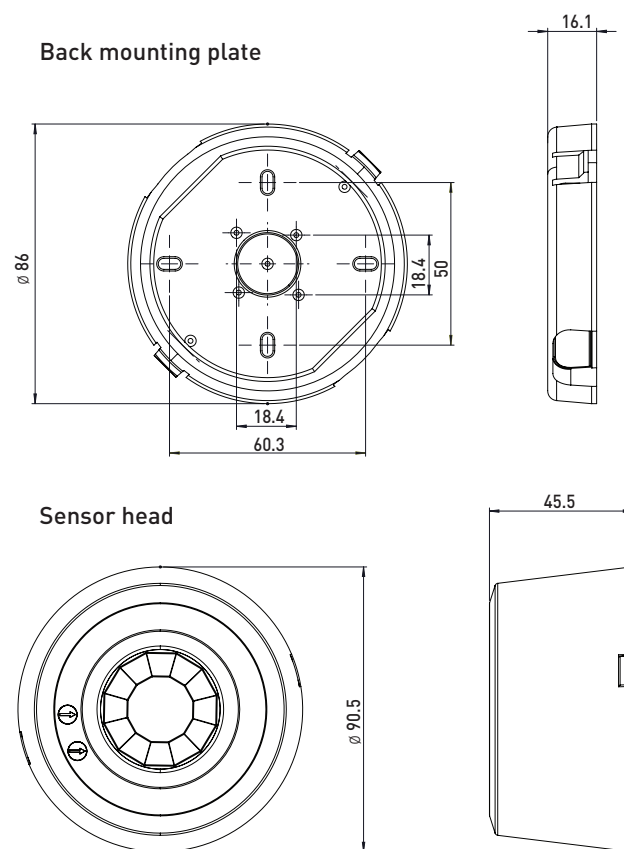

Helvar Ltd
Hawley Mill
Hawley Road
DARTFORD
DA2 7SY
UNITED KINGDOM
www.helvar.com