

User Guide

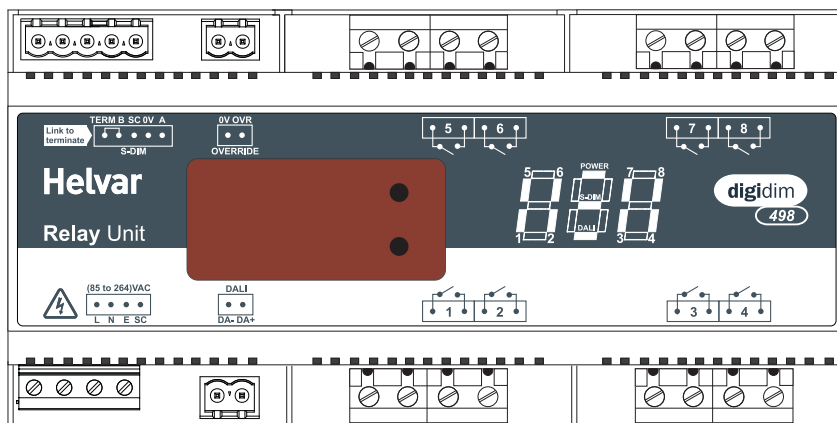

1: Product Description

The Digidim 498 8-channel relay unit is fitted with high inrush specification relays rated at 16 A per channel, which handle short-lived high peak inrush currents during switch-on of loads.

The 498 can operate with either a Helvar Digidim or Imagine lighting control system and is DIN-rail mounted for ease of installation. The 498 has an intuitive LED segment display and push buttons known as the 'Control Panel', for monitoring, manual configuration and control purposes.

The Control Panel comprises:

- A 3-digit, 7-segment LED display (normally showing device activity)
- Two buttons ('up' and 'down') to the right of the display, to view and configure parameters



Control panel

2: Installation

2.1

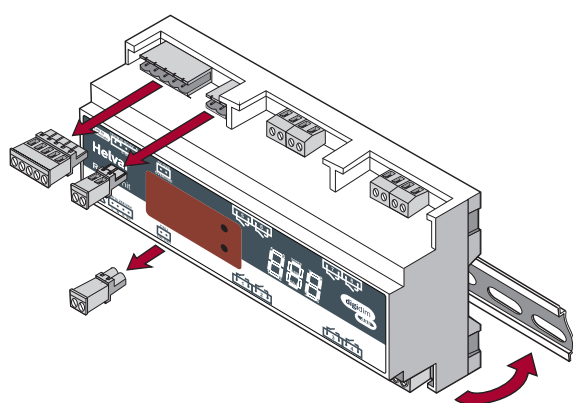

Location

- For installation in a restricted access location only

Position & Ventilation

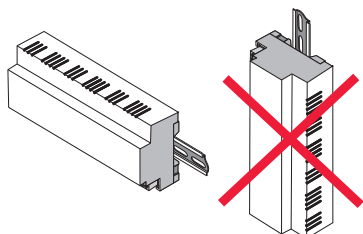

- Install the unit horizontally to allow for heat dissipation
- Any enclosure must provide adequate cooling ventilation

2.2

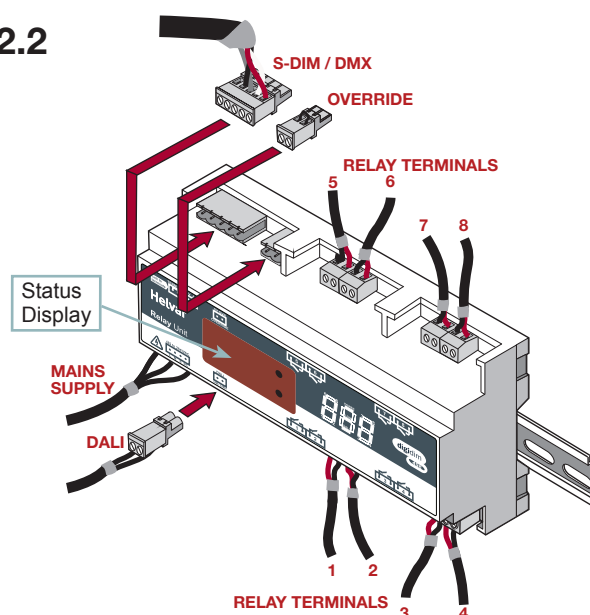

Electrical

- Do not connect DALI and S-DIM / DMX at the same time
- Isolate the mains supply before installation
- The external supply must be protected: 6 A MCB max.
- All DALI and Mains cabling must be 230 V mains rated

Cable information

Cable	Cable Type
DALI	2-wire mains-rated. 0.5 mm ² to 1.5 mm ² Max. length 300 m (with 1.5 mm ² cable). Example: Belden 8471
Mains cable / Relays	Max. 2.5 mm ² stranded (4 mm ² solid).
S-DIM / DMX	Low loss RS485 Type (multi-stranded, twisted and shielded). Note: One twisted pair for A and B (85 Ω to 100 Ω impedance), one core or twisted pair for 0 V, and shield for screen. Size: 0.22 mm ² to 1.5 mm ² . Core: 3 or 4 + Screen. Max. Length 1000 m (low-loss cable). Example: Belden 8102 or Alpha 6222C
Override	2-wire. 0.5 mm ² to 1.5 mm ² . Max. cable length 50 m

3: Connections

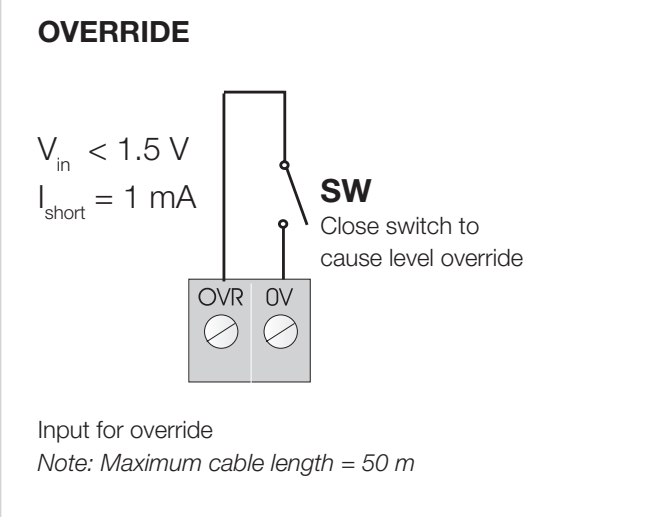
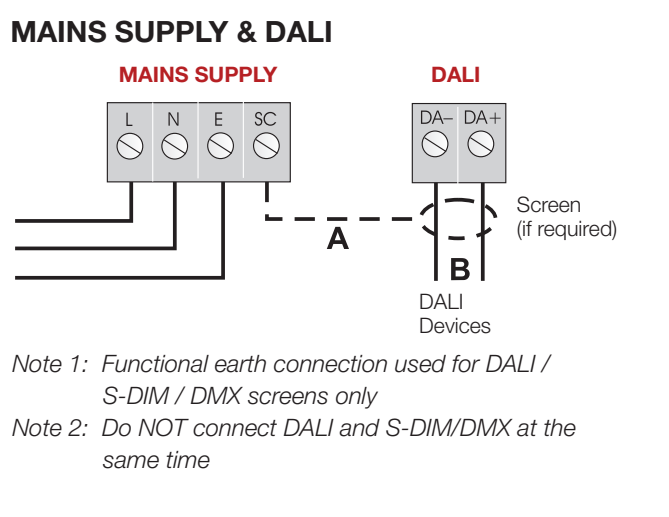
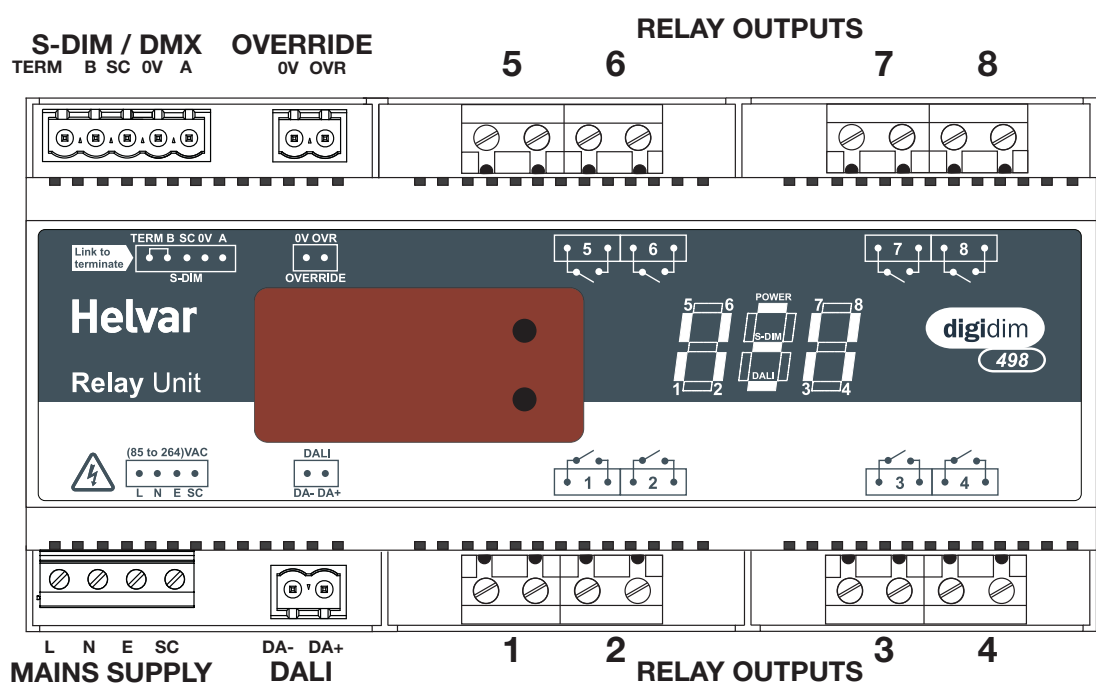

S-DIM / DMX

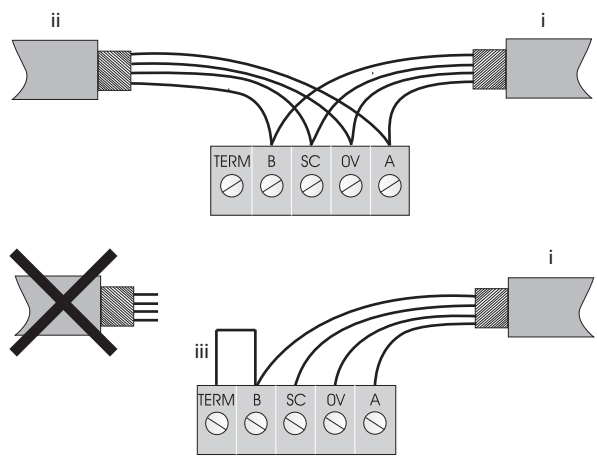

i = S-DIM or DMX Data Cable (from previous device)
ii = S-DIM or DMX Data Cable (to next device)
iii = Link for Termination (if unit is at end of S-DIM/DMX cable line)
Note: Keep unshielded wire lengths to a minimum

4: Power Up

During power up, the following sequence is displayed on the LED Control Panel.

Each display is held for one second. At the end of this sequence, the 'Status' display appears.

Start-up Sequence:

1. All segments on

2. Product model

3. Software version

4. Normal Operation (Status Display)

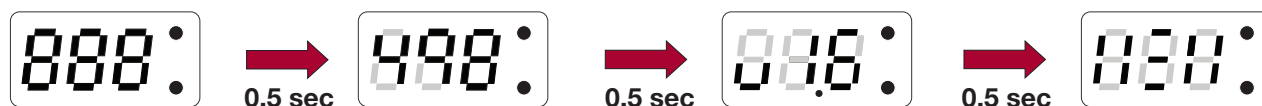

5. Understanding the Status Display

The 'Status' display is the default view in operation. It is the starting point for navigating and configuring the 498.

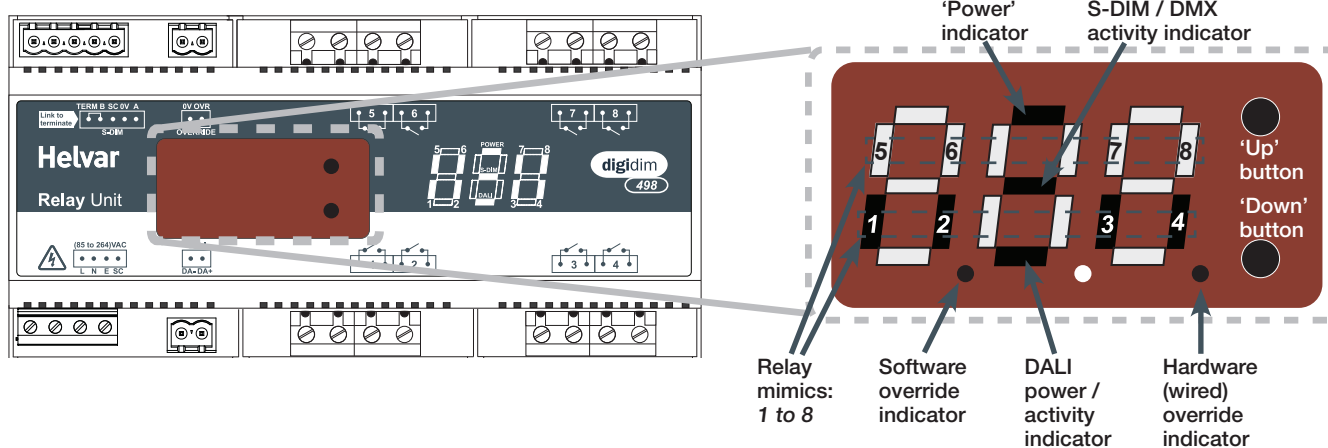

Key and LED Descriptions:

'Power' indicator

The 'power' indicator (top segment of the middle digit) is always on when the 498 status display is active.

S-DIM / DMX activity indicator

The S-DIM / DMX activity indicator (centre segment of the middle digit) is normally off, and flashes on intermittently if any S-DIM / DMX activity (communications) is directed to a channel within the unit.

Relay mimics

The relay mimics (1, 2, 3, 4, 5, 6, 7 and 8) are illuminated when the relays are on, and not illuminated when the relays are off (0%).

Software override indicator

The decimal point on the left is illuminated to indicate software override from the 910 / 920 router. The middle segment of the display will also flash.

DALI power / activity indicator

The DALI indicator (bottom segment of the middle digit) is off if there is no DALI power, and on if DALI power is present. If any DALI activity is directed to a channel within the device, the indicator blinks off.

Hardware (wired) override indicator

The decimal point on the right is illuminated to indicate wired override. The middle segment of the display will also flash.

6. Navigating the 498 Menu

The status display LEDs on the front of the unit are lit in the following way when power is on:

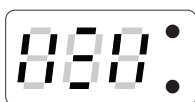

Navigate through the 498 menus using the up / down push buttons located on the front of the unit.

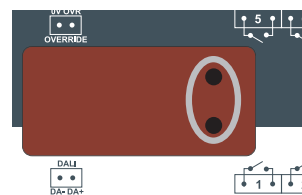

Navigate the 498 menu to configure the unit.

Cycle through the menu:

1) Press both buttons simultaneously to cycle through the menus.

Tip! To cycle through the menus quickly, hold down both buttons.

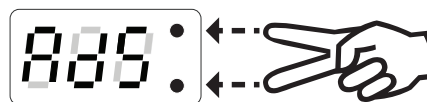

Select the desired channel to modify:

2) At your chosen function, quickly press up or down button to scroll through the channel destinations. These are the channels which will be affected by the following settings:

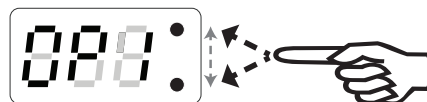

Note: Select 'ALL' to alter all channels simultaneously.

Modify function settings:

3) Hold up or down buttons to alter the levels, settings, fade times, output modes (dependent on function activated). See section 7 for further details.

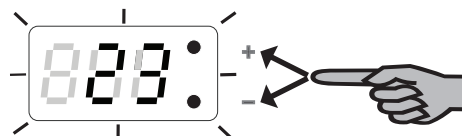

Note: LEDs blink if the value has been changed and not yet stored.

Save changes:

4) Hold both buttons together to save the change.

The LEDs will show 888 for 1 second to confirm setting is stored.

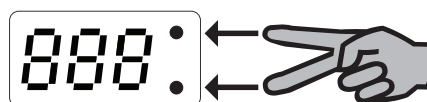

Back To Previous Menu

To go back to the previous menu, do not touch the buttons for 5 seconds.



Back To Status Display

10 seconds of inactivity returns the 498 to the Status Display screen.

Tip! You can also return to the status display by cycling through all the menus.

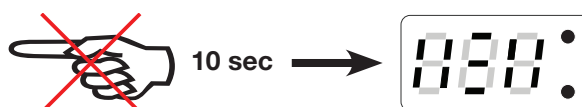

7. Configuring the 498

Various settings can be configured via the control panel.

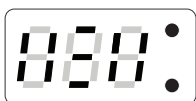

Status Display / Set Channel Level

Set Channel Levels (0 - 100%) by using the push buttons in 'Status' menu. Select the channel(s) to change, then hold the up or down button to alter levels.

For further information, refer to the 'Quick Start Guide' in Section 10.

Note: You can access 'Status Display / Set channel level' mode whilst the device is in override mode, but it is not possible to change the channel levels.



Number of Channels

Set the number of device channels to 2, 4 or 8.

Note: In 2-Channel mode: 1 + 2 + 3 + 4; 5 + 6 + 7 + 8

In 4-Channel mode: 1 + 2; 3 + 4; 5 + 6; 7 + 8

In 8-Channel mode: 1; 2; 3; 4; 5; 6; 7; 8



Set S-DIM / DMX Address

Set the S-DIM or DMX address for each channel.

Select **bRS** to set the S-DIM or DMX base address.

S-DIM: 252 addresses available.

DMX: 512 addresses available.

Note: DMX updates are disabled while using manual control.



Set DALI Address

Set the DALI address for each channel. Select **bRS** to set the DALI base address.

DALI: 64 addresses available.



Enable/Disable DMX

Enable or disable DMX from this menu.

When DMX is enabled ('On') it will use the S-DIM address.

There is no channel select option; it is a global setting.

Note: DMX is disabled by default.



Minimum Fade Time

Set the minimum fade time for the channels.

Select the minimum fade time for each channel individually or **ALL** channels simultaneously.

Minimum fade time can be set to: 1.00 second, 0.50 seconds, 0.15 seconds and 0.02 seconds.



Override Level

The override level can be configured for individual relay channels or **ALL** channels and ranges from 0 to 100. It can be manually tested via the override test function ('**O-E**')

Note 1: When S-DIM/DMX is connected, the override settings in the router (configured using Designer software) will take precedence over the device's override settings, unless you configure the software to use the device override settings.

Note 2: When the unit is running in override, the left decimal point is illuminated and the middle digit of the screen flashes in the status screen.



Override Test

Test that the override level (set in the previous mode) functions as required, by choosing ON or OFF. The unit performs as if an override has been caused by the override input connection.

Note 1: By switching this setting to ON it will not be possible to manually edit the channel levels in 'Status Display / Set Channel Level' menu.

Note 2: To change the channel levels, ensure that override is switched off.

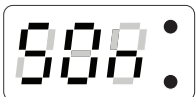

Switch-On Level (S-DIM / DMX only)

Set the Switch-on levels for S-DIM / DMX channels.

S-DIM: 2% – 64% (Default 2%);

DMX: 0.1% - 64% (Default 0.1%)



Set Minimum Level (DALI only)

Set the minimum level for DALI channels.

DALI: 0.1% - 100% (Default 0.1%)

Note: The minimum level value will be overridden if the 454 is connected to a 910 or 920 router system.

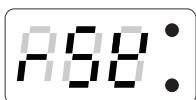

Restore to Factory Default

Hold the up or down buttons for 10 seconds in this menu.

The decimal points will light up in sequence, and then all LEDs will be on for 1 second to confirm that factory settings have been restored.

Note: Restore to Factory Default will cause all existing manually configured settings to be lost.

8. Troubleshooting and Error Messages

If an error occurs, please contact Helvar Support (see www.helvar.com for details).

These details may be of assistance should an error message be displayed:



Communications Error (S-Dim/DMX only)

Err indicates a problem with the S-DIM or DMX communications. Please check wiring and terminations. Make sure no two channels have the same addresses on the network, and that the S-DIM / DMX mode is selected correctly.

Important considerations

- Do not connect DALI and S-DIM / DMX at the same time.
- If DMX does not work then please check that it has been switched on in the *dim* menu. Then it is possible to set the DMX addresses in the *Ad5* menu. See page 6 for further information.

9. DALI Physical Selection

Physical selection mode allows loads and controls to be grouped together. It can be activated for a piece of equipment in a number of ways, including by using a Helvar remote control unit, or by using Designer or Toolbox software. Refer to the equipment instructions for details.

Follow these steps to use the module to identify a piece of equipment using physical selection mode.

Note 1: Use the Remote Control Handset, with a Digidim control device, to put the device into 'Physical Selection' mode. Refer to the 'Digidim Lighting Control – Designing, Specifying and Installing' System Manual (doc. no. 7860038), section 5 - 7 Physical Selection.

Note 2: The 'Physical Selection' display is identical to the 'Status Display / Set Channel Level' display, except for the decimal point flashing.

1. Put the device into physical selection mode.
The centre decimal point on the display screen flashes, which indicates that the device has entered 'Physical Selection' mode.
2. From the control panel, repeatedly press 'up' or 'down' button to scroll between channels.
The selected channel mimic (s) flashes.
3. To physically select the channel, hold the 'up' or 'down' button.
The centre decimal point stops flashing for 2 seconds to indicate a successful programming.
4. Repeat step 2 and 3 for each channel, as necessary.
5. End 'Physical Selection' mode (at the device). *You are returned to the 'Status display.*

10. 498 Quick Start Guide

498 Quick Start Guide

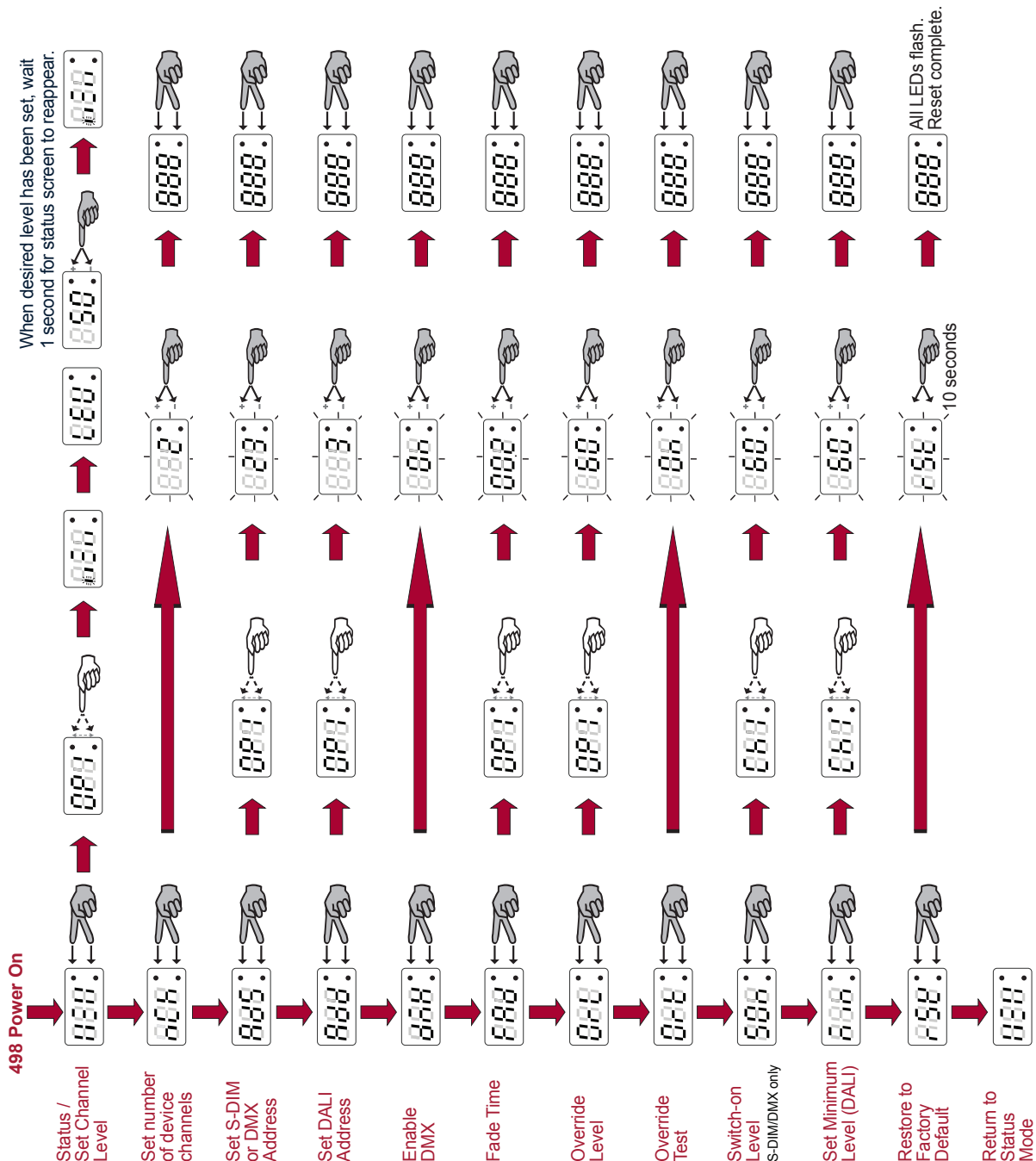

Navigation

- Press both buttons at the same time to cycle through the menu.
- Press up or down button to scroll through the channel destinations.
- Hold up or down button to alter the levels, settings, fade times, output modes (dependent on active mode).
- Hold both buttons together to store the setting.

Back to status display



Notes

- ALL:** Select **ALL** channels. Where available, select, 'ALL' to set all available channels.
- UP:** Variable level notice. A UP level notice occurs in certain modes if you are changing levels for ALL channels (via the ALL function) but the individual channel levels vary.
- 888:** Set DALI or S-DIM/DMX base addresses. From the Rdd menu, select 888 to set the DALI base address. From the Rf5 menu, select 888 to set the S-DIM or DMX base address.

Technical Data

Connections

Mains/relay:	Solid core: up to 4 mm ² Stranded: 2.5 mm ²
DALI:	0.5 mm ² - 1.5 mm ² (max. 300 m @ 1.5 mm ²)
S-DIM / DMX:	0.22 mm ² - 1.5 mm ² low loss RS485 Type (multi-stranded, twisted and shielded)
Relay channels:	2 channels per 4-way connector; 2.5 mm ² stranded

Power

Mains Supply:	85 - 264 VAC, 45 - 65 Hz
Power Consumption:	2.6 W
Power Circuit Protection:	6 A MCB maximum. The external supply must be protected.
DALI Consumption:	2 mA

Inputs

Communication:	DALI, S-DIM and DMX
Override:	Wired override input
User interface:	2 push buttons for configuration

Relay contacts

Channels:	8
Relay contacts:	High inrush (200 µs at 800 A), single pole normally open (SPNO)
Max. load per contact:	16 A resistive / incandescent; 10 A HID (cos φ = 0.6)







For ballasts, quantity is limited by MCB, refer to manufacturer's data. Relay circuit external protection must not exceed 16 A type C MCB.

Operating and Storage Conditions

Ambient Temperature:	0°C to 40°C
Relative Humidity:	90% max, non-condensing
Storage Temperature:	-10°C to +70°C

Mechanical Data

Housing:	DIN-rail case; 9U
Weight:	400 g
IP Rating:	IP30 (00 at terminals)

-  For further information see www.helvar.com
-  Für weitere Informationen siehe www.helvar.com
-  Lisätietoja: www.helvar.com
-  För mer information besök www.helvar.com
-  Pour plus d'informations, visitez www.helvar.com
-  Per ulteriori informazioni consultare www.helvar.com
-  Дополнительную информацию см на www.helvar.com

Conformity and Standards

DALI:	According to DALI standard IEC 62386, with Helvar additions
S-DIM:	According to Helvar S-DIM protocol
DMX:	According to DMX512-A protocol
Environment:	Complies with WEEE and RoHS directives

EMC

Emission:	EN 61000-6-3
Immunity:	EN 61 547
Safety:	EN 60 950
Isolation:	4 kV between every connector (apart from common CO ballast output terminals and S-DIM and Override connectors)

Dimensions

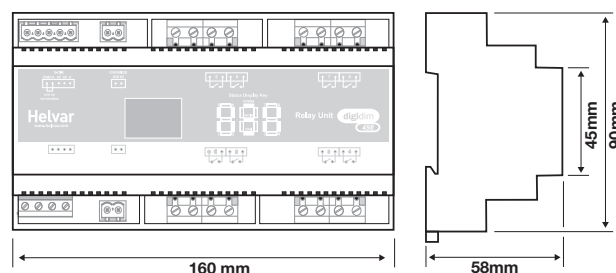

www.helvar.com