

## 12 W SELV Dimmable DALI-2 LED driver

Product code: 5764

12 W 220 – 240 V 50 – 60 Hz

- Extremely compact dimensions (80 x 41 x 22 mm) for flexible usage
- DALI-2 certified LED driver
- SELV output protection for safety and flexibility in luminaires
- Amplitude dimming for high quality light output, 1 - 100 % dimming range
- DALI251-253 data memory banks for diagnostics and energy data
- Ideal solution for Class I and Class II



### Functional Description

- Adjustable constant current output: 180 to 700 mA
- Output current setting programmable via software NFC / DALI
- Optional equipotential terminal for glow-effect removal and LED load potential balancing, see page 6 for details
- D4i compatible Smart Data features, e.g. OEM customer and luminaire data, energy reporting, diagnostics and maintenance
- Suitable for emergency lighting applications with central battery system requirements (e.g. Eaton-CEAG, Inotec). EN60598-2-22 compatibility. To enable DC operation, see page 5 for connection details
- Constant Light Output (CLO), adjustable up to 100 000 h (default disabled)
- Overload, open & short circuit protection

### Mains Characteristics

|                                  |                                                          |
|----------------------------------|----------------------------------------------------------|
| Nominal rated voltage range      | 220 V – 240 V, 50 – 60 Hz                                |
| Rated emergency voltage range    | 196 V – 250 V, 0 Hz                                      |
| AC voltage range                 | 198 VAC – 264 VAC                                        |
| DC voltage range                 | 176 VDC – 280 VDC                                        |
| Mains current at full load       | 0.06 – 0.07 A                                            |
| Frequency                        | 50 Hz – 60 Hz                                            |
| Stand-by power consumption       | < 0.3 W                                                  |
| THD at full power                | < 10 %                                                   |
| Tested surge protection          | 2 kV L/N-GND (IEC 61000-4-5)<br>1 kV L-N (IEC 61000-4-5) |
| Tested fast transient protection | 2 kV (IEC 61000-4-4)                                     |

### Insulation between circuits & driver case

|                                      |                              |
|--------------------------------------|------------------------------|
| Mains circuit - SELV circuit         | Double/reinforced insulation |
| DALI circuit - SELV circuit          | Double/reinforced insulation |
| Mains circuit - DALI circuit         | Basic insulation             |
| Mains, DALI and output - Driver case | Double/reinforced insulation |
| EQUI - Mains circuit                 | Double/reinforced insulation |
| EQUI - SELV circuit                  | Basic insulation             |

### Load Output (SELV <60 V)

|                                                    |                           |
|----------------------------------------------------|---------------------------|
| Output current ( $I_{out}$ )                       | 180 mA (default) – 700 mA |
| Accuracy                                           | ± 5 %                     |
| Ripple                                             | < 2%* at ≤ 120 Hz         |
| *) Low frequency ripple, LED load: Cree XP-G LEDs. |                           |
| $U_{out}$ (max) (abnormal)                         | 60 V                      |
| EOF <sub>1</sub> (EL use)                          | 15 % <sup>1)</sup>        |
| PstLM                                              | 1.0 <sup>2)</sup>         |
| SVM                                                | 0.4 <sup>2)</sup>         |

1) By default setting, available range 1...100 % 2) Full load, LED load: Cree XP-G LEDs

| $I_{LED}$                          | 180 mA       | 300 mA     | 700 mA     |
|------------------------------------|--------------|------------|------------|
| $P_{Rated}$                        | 0.15...7.2 W | 1.5...12 W | 3.5...12 W |
| $U_{LED}$                          | 5 - 40 V     | 5 - 40 V   | 5 - 17 V   |
| PF ( $\lambda$ ) at full load      | 0.90         | 0.95       | 0.95       |
| Efficiency ( $\eta$ ) at full load | 82 %         | 88 %       | 84 %       |

## Operating window

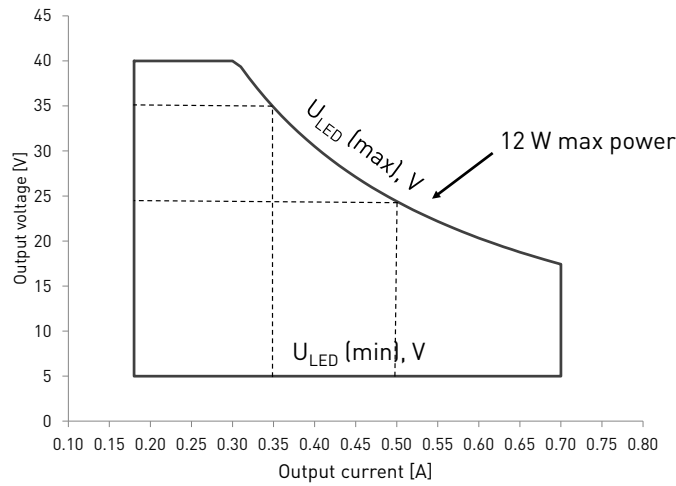

Note: Dimming between 1% - 100% possible across the operating window, restricted by the absolute minimum dimming current of 3 mA.

## Driver performance

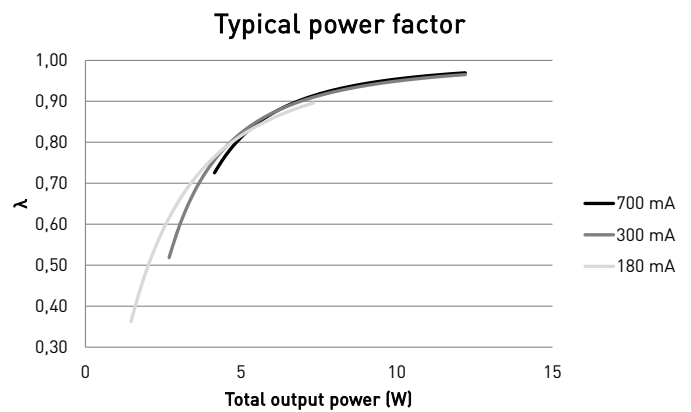
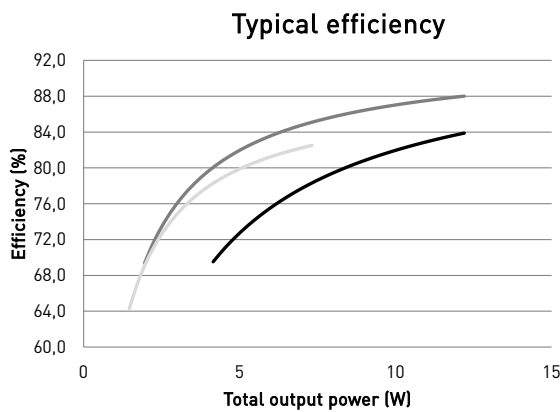

## Operating Conditions and Characteristics

|                                                  |                                                                                         |
|--------------------------------------------------|-----------------------------------------------------------------------------------------|
| Absolute highest allowed $t_c$ point temperature | 85°C                                                                                    |
| $T_c$ life (50 000 h) temperature                | 75°C                                                                                    |
| Ambient temperature range                        | -25 °C ... +50 °C <sup>1)</sup>                                                         |
| Storage temperature range                        | -40 °C ... +80 °C                                                                       |
| Maximum relative humidity                        | No condensation                                                                         |
| Life time(90 % survival rate)                    | 100 000 h, at $t_c = 65$ °C<br>50 000 h, at $t_c = 75$ °C<br>35 000 h, at $t_c = 85$ °C |

<sup>1)</sup> For other than independent use, higher  $t_a$  of the controlgear possible as long as highest allowed  $t_c$  point temperature is not exceeded

## Amplitude dimming technology

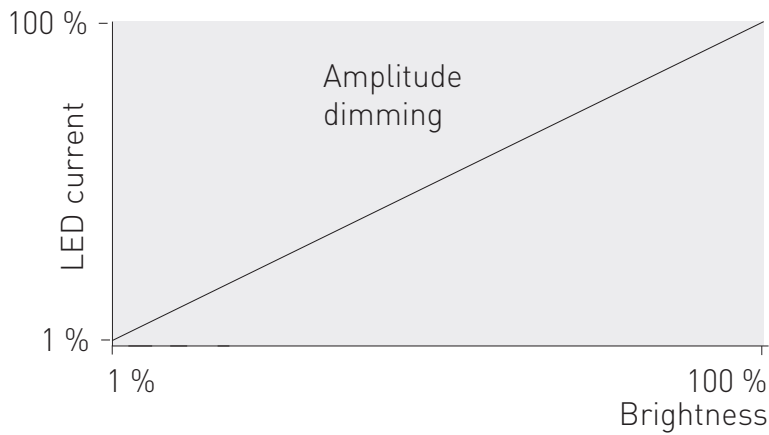

| Dimming range | Dimming technology |
|---------------|--------------------|
| 1 % – 100 %   | Amplitude (DC)     |

LC12TINY-DA-180-700 LED driver implements amplitude dimming technology across whole dimming range. Amplitude dimming offers the best available technology for dimming the light output in an accurate and flicker-free way to ensure high quality lighting in even the most demanding situations such as camera recording applications. Amplitude dimming technology complies with IEEE 1789-2015 recommendations of current modulation to mitigate health risks to viewers.

## Wireless configuration

LC12TINY-DA-180-700 LED driver is equipped with NFC wireless technology for effortless configuration of the driver via Helvar Driver Configurator Support. Helvar Driver Configurator enables easy-to-use automatic configuration of the driver parameters via NFC, without mains or DALI connection to the driver. The most popular MD-SIG qualified NFC readers are supported giving flexibility for the operator. For further information about the usage with Helvar Driver Configurator, please see the user guide at [www.helvar.com](http://www.helvar.com)

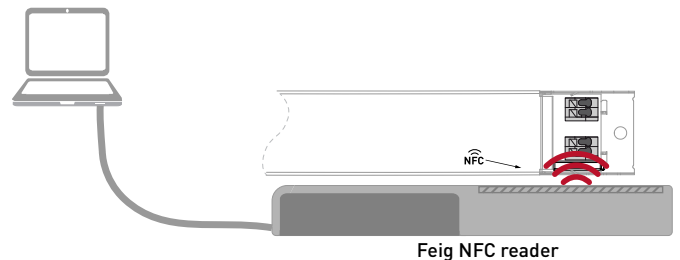

## Quantity of drivers per miniature circuit breaker 16 A Type C

| Based on inrush current $I_{peak}$ | Typ. peak inrush current $I_{peak}$ | 1/2 value time, $\Delta t$ | Calculated energy, $I_{peak}^2 \Delta t$ |
|------------------------------------|-------------------------------------|----------------------------|------------------------------------------|
| 2300 pcs*                          | 3.6 A                               | 29 $\mu s$                 | 0.0003 A <sup>2</sup> s                  |

\*the inrush current is not the limiting factor for the products per MCB, please notice the continuous current limitations.

### CONVERSION TABLE FOR OTHER TYPES OF MINIATURE CIRCUIT BREAKER

| MCB type | Relative quantity of LED drivers |
|----------|----------------------------------|
| B 10 A   | 37 %                             |
| B 16 A   | 60 %                             |
| B 20 A   | 75 %                             |
| C 10 A   | 62 %                             |
| C 16 A   | 100 % (see table above)          |
| C 20 A   | 125 %                            |

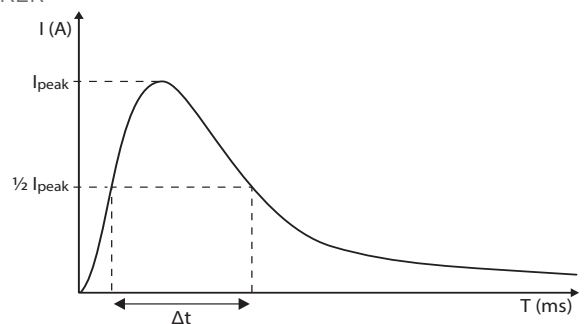

### CONTINUOUS CURRENT

Total continuous current of the drivers and installation environment must always be considered and taken into calculations when installing drivers behind miniature circuit breaker. Example calculation of total drivers amount limited by continuous current:  $n(I_{cont}) = [16 A (I_{nom,Ta}) / \text{“nominal mains current with full load”}] \times 0.76$ . This calculation is an example according to recommended precautions due to multiple adjacent circuit breakers (> 9 MCBs) and installation environment ( $T_a$  30 degrees); variables may vary according to the use case. Both inrush current and continuous current calculations are based on ABB S200 series circuit breakers. More specific information in ABB series S200 circuit breaker documentation.

NOTE! Type C MCB's are strongly recommended to use with LED lighting. Please see more details in "MCB information" document in each driver product page in "downloads & links" section.

## DC emergency lighting functionality

When AC supply is switched to DC, the LED driver will recognise this and switch to emergency lighting mode. The light level will be adjusted to 15 % of the nominal AC operation output current by default. The DC light level cannot be adjusted or turned off, unless “DC dimming” is specifically enabled through Helvar Driver Configurator. When the AC is switched back on, the driver returns to normal operation. The internal temperature protection feature can never force the light level off or below the set emergency level in DC mode.

## Internal thermal protection

This LED driver has built-in active internal thermal protection. This feature protects the LED driver by limiting the maximum output current within one minute fade time when the temperature rises enough above the specified operating environment of the driver. If the temperature exceeds a certain predefined critical point, the output will be switched off and returns automatically once the temperature decreases below the threshold. The default behavior is shown in the graph on the right.

By factory default,

- The internal thermal protection is enabled
- The derating temperature point is set to 90°C
- Derating level to 30 %
- Shutdown temperature point to 110°C

Note that the internal measured temperature does not equal  $T_c$  temperature of the driver!

Internal thermal protection feature can be either disabled or manually adjusted to trigger earlier if desired. Configuring the internal thermal protection is done via Helvar Driver Configurator.

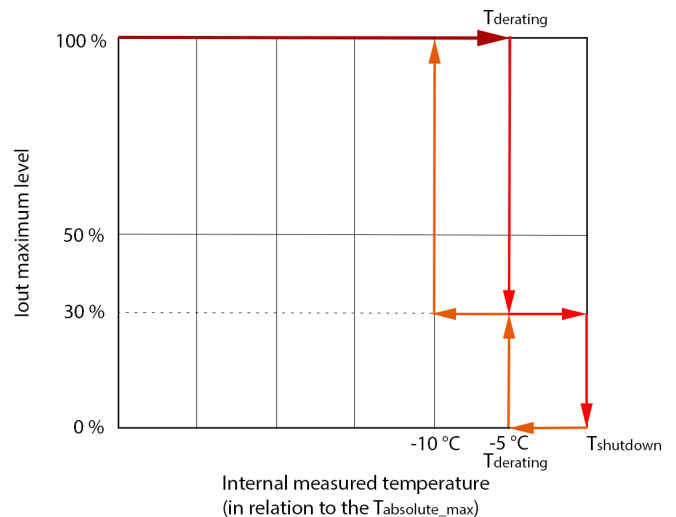

## D4i-compatible Smart Data Features (DALI 251-253)

LC12TINY-DA-180-700 LED driver has integrated Smart Data features, which monitor, gather and provide key data about the LED driver usage and internal parameters through DALI. This useful data provided by LED driver enables various applications and integrations into data management and IoT services, establishing the Helvar LED drivers as key components in the latest generation of smart luminaires.

The DALI parts 251-253 include:

- OEM Customer data (DALI part 251)
- Energy reporting (DALI part 252)
- Diagnostics and maintenance (DALI part 253)

## Connections and Mechanical Data

|                                   |                                           |
|-----------------------------------|-------------------------------------------|
| Wire size                         | 0.5 mm <sup>2</sup> – 1.5 mm <sup>2</sup> |
| Wire type                         | Solid core and fine-stranded              |
| Wire insulation                   | According to EN 60598                     |
| Maximum driver to LED wire length | 1.5 m                                     |
| Weight                            | 59 g                                      |
| IP rating                         | IP20                                      |

## Connections

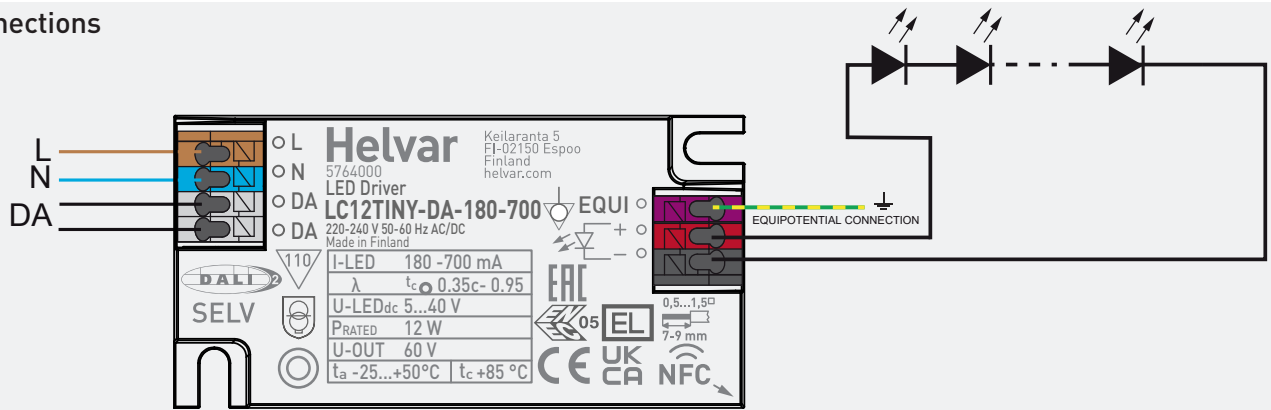

Note:

- Not suitable for load side switching operation
- For DC emergency operation, the Line (L) and Neutral (N) MUST be connected in the correct order as shown in image above.
- The Equipotential terminal (EQUI) can be used for glow effect removal or reducing potential differences. It is optional to connect.

## Dimensions (mm)

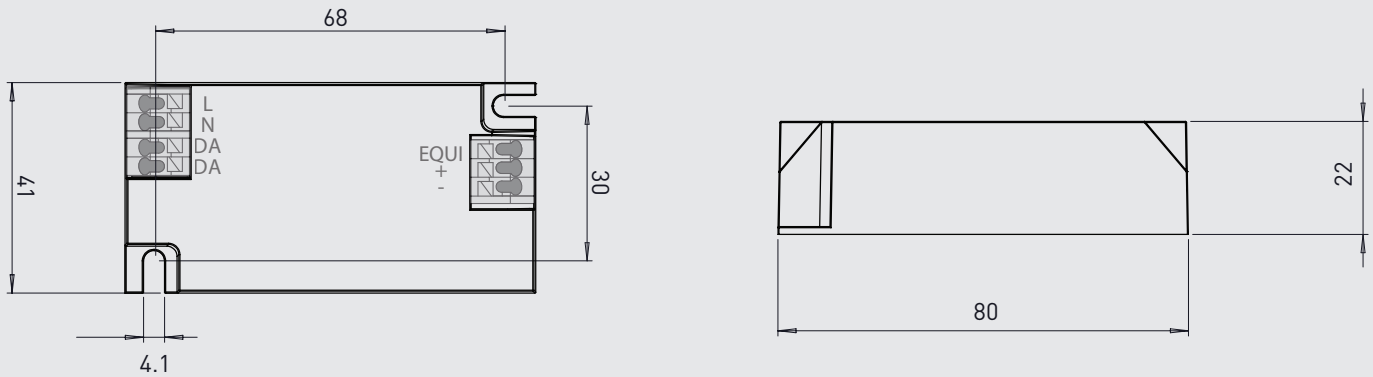

LC12TINY-DA-180-700 LED driver is suited for built-in usage in luminaires. In order to have safe and reliable LED driver operation, the LED luminaires will need to comply with the relevant standards and regulations (e.g. IEC/EN 60598-1). The LED luminaire shall be designed to adequately protect the LED driver from dust, moisture and pollution. The luminaire manufacturer is responsible for the correct choice and installation of the LED drivers according to the application and product datasheets. Operating conditions of the LED drivers may never exceed the specifications as per the product datasheet.

## Installation & operation

### Maximum ambient and $t_c$ temperature:

- For built-in components inside luminaires, the  $t_a$  ambient temperature range is a guideline given for the optimum operating environment. However, integrator must always ensure proper thermal management (i.e. mounting base of the driver, air flow etc.) so that the  $t_c$  point temperature does not exceed the  $t_c$  maximum limit in any circumstance.
- Reliable operation and lifetime is only guaranteed if the maximum  $t_c$  point temperature is not exceeded under the conditions of use.

### Miniature Circuit Breakers (MCB)

- Type-C MCB's with trip characteristics in according to EN 60898 are recommended.
- Please see more details in "MCB information" document in each driver product page in "downloads & links" section.

### EQUI terminal

- EQUI terminal is optional connection to be connected to LED module and other metal parts of luminaire. This gives the LED modules additional protection against high voltage potential differences, when the metal parts are all connected to same ground potential.
- EQUI terminal connection can also be used for glow effect removal

## Functionality in abnormal conditions

### No load

When open load is detected, the driver will go to standby mode and remain in automatic recovery status. In automatic recovery mode, the driver will check every four seconds if the load has been reconnected. Once that happens, it returns to normal operation.

### Short circuit (/underload)

When short circuit is detected, driver will go to standby mode. It will return to normal operation through DALI light level OFF -> ON command or through mains reset.

### Overload

When overload/voltage is detected, driver will act similarly to no load situation, it will go to standby mode and remain in automatic recovery status. In automatic recovery mode, the driver will check every four seconds if the load has been reconnected. Once that happens, it returns to normal operation.

### Internal overtemperature

When the driver exceeds the  $T_c$  max operating temperature, soon above that point the driver will start decreasing the maximum output current. Details about the operation in page 3 "Internal Thermal Protection"

### AC to DC emergency lighting mode

When AC supply is switched to DC, the LED driver will recognise this and switch to emergency lighting mode. Details about the operation in page 3 "DC emergency lighting functionality".

NOTE! For DC functionality to work correctly, Line (L) must be connected to brown connector and Neutral (N) to blue connector.

## Conformity & standards

|                                                                                                             |                        |
|-------------------------------------------------------------------------------------------------------------|------------------------|
| General and safety requirements                                                                             | EN 61347-1             |
| Particular safety requirements for DC or AC supplied electronic control gear for LED modules                | EN 61347-2-13          |
| Additional safety requirements for AC or DC supplied electronic controlgear for emergency lighting          | EN 61347-2-13, Annex J |
| Thermal protection class                                                                                    | EN 61347, C5e          |
| Mains current harmonics                                                                                     | EN IEC 61000-3-2       |
| Limits for voltage fluctuations and flicker                                                                 | EN 61000-3-3           |
| Radio frequency interference                                                                                | EN IEC 55015           |
| Immunity standard                                                                                           | EN 61547               |
| Performance requirements                                                                                    | EN IEC 62384           |
| <b>Digital addressing lighting interface:</b>                                                               |                        |
| General requirements for DALI system                                                                        | EN 62386-101 (DALI-2)  |
| Requirements for DALI control gear                                                                          | EN 62386-102 (DALI-2)  |
| Requirements for control gear of LED modules (DALI Device Type 6)                                           | EN 62386-207 (DALI-2)  |
| Memory Bank 1 extension                                                                                     | DALI Part 251          |
| Energy Reporting                                                                                            | DALI Part 252          |
| Diagnostics & Maintenance                                                                                   | DALI Part 253          |
| Recommended Practices for Modulating Current in High-Brightness LEDs for Mitigating Health Risks to Viewers | IEEE 1789-2015         |
| Compliant with relevant EU directives                                                                       |                        |
| RoHS/REACH compliant                                                                                        |                        |
| ENEC and CE / UKCA marked                                                                                   |                        |

## Label symbols



Safety isolating control gear with short circuit protection (SELV control gear).



Double insulated control gear suitable for built-in use.



Thermally controlled control gear, incorporating means of protection against overheating to prevent the case temperature under any conditions of use from exceeding 110 °C.



DALI-2 certified control gear.



AC/DC supplied electronic control gear for emergency lighting purposes intended for connection to a centralized emergency power supply.



Equipotential terminal for glow effect removal and equalising the potential difference in LED modules.